

**INSTALLATION  
AND  
OPERATING  
INSTRUCTIONS**

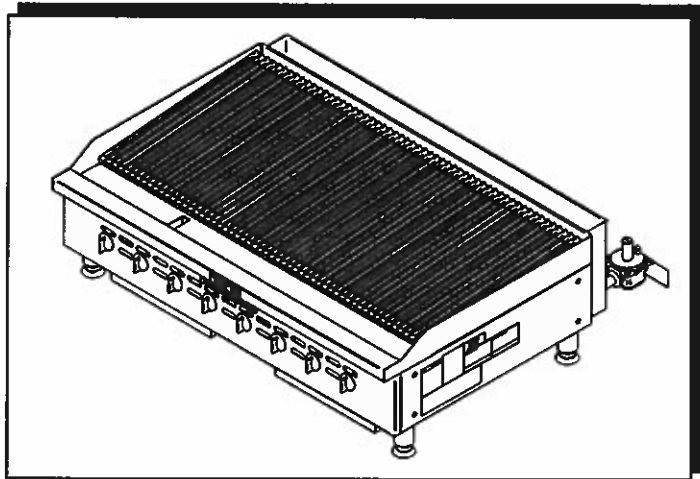

## Heavy Duty Gas Char-Broilers

MODELS: HDCB-2424, HDCB-2436, HDCB-2448, HDCB-2460, HDCB-2472

&

## Heavy Duty Charrock Gas Broilers

MODELS: HDCRB-2424, HDCRB-2436, HDCRB-2448, HDCRB-2460, HDCRB-2472

### IMPORTANT FOR FUTURE REFERENCE

Please complete this information and retain this manual for the life of the equipment. For Warranty Service and/or Parts, this information is required.

\_\_\_\_\_ Model Number

\_\_\_\_\_ Serial Number

\_\_\_\_\_ Date Purchased



**FOR YOUR SAFETY:** Do not store or use gasoline or other flammable vapors or liquids in the vicinity of this or any other appliance.



**WARNING:** Improper installation, adjustment, alteration, service or maintenance can cause property damage, injury or death. Read the installation, operating and maintenance instructions thoroughly before installing, or servicing this equipment.



**WARNING:** Instructions must be posted in a prominent location. All safety precautions must be taken in the event the user smells gas. Safety information can be obtained from your local gas supplier.



P/N 8835310 1-09

**BAKERS PRIDE OVEN CO., INC.**



30 Pine Street  
New Rochelle, NY 10801

(914) 576-0200 Phone  
(914) 576-0605 Fax



(800) 431-2745 US & Canada  
www.bakerspride.com WebAddress



## TABLE OF CONTENTS:

<u>ITEM</u>	<u>PAGE</u>	<u>ITEM</u>	<u>PAGE</u>
Safety Precautions.....	3	Cleaning/Maintenance .....	11
General Installation Instructions.....	4	Service/Repair .....	12
Specifications & Dimensions .....	4	Troubleshooting Guide.....	12
Conversion.....	8	Replacement Parts Lists & Exploded Views.....	13
Lighting Instructions .....	9	Warranty .....	19
Operating Instructions.....	10		

	<p><b>CAUTION:</b> These models are designed, built, and sold for commercial use. If these models are positioned so the general public can use the equipment, make sure that cautions, warnings, and operating instructions are clearly posted near each unit so that anyone using the equipment will use it correctly and not injure themselves or harm the equipment.</p>	
---	---	---

	<p><b>WARNING:</b> Improper installation, adjustment, alteration, service or maintenance can cause property damage, injury or death. Read the installation, operating and maintenance instructions thoroughly before installing or servicing this equipment.</p>	
---	--	---



	<p><b>WARNING:</b> For your safety do not store or use gasoline or other flammable vapors and liquids in the vicinity of this or any other appliance. Keep the area free and clear of combustibles. (See ANZI Z83. 14B, 1991).</p>	
---	--	---

	<p><b>NOTICE:</b> Instructions to be followed if anyone smells gas should be posted in a prominent place. These may be obtained from the gas supplier.</p>	
---	--	---

### GAS PRESSURE

The appliance and it's individual shutoff valve (to be supplied by user) must be disconnected from the gas supply piping system during any pressure testing of that system at test pressures in excess of ½ psi (3.45 kPa). *NOTE:* Gas shutoff valve is supplied on CE models.

The appliance must be isolated from the gas supply piping system by closing it's individual manual shut-off valve during any pressure testing of the gas supply piping system at test pressures equal to or less than ½ psi (3.45 kPa).

	<p><b>WARNING:</b> A factory authorized agent should handle all maintenance and repair. Before doing any maintenance or repair, contact Bakers Pride.</p>	
---	---	---

Congratulations on your purchase of Bakers Pride commercial cooking equipment. Bakers Pride takes pride in the design and quality of our products. When used as intended and with proper care and maintenance, you will experience years of reliable operation from this equipment. To ensure best results, it is important that you read and follow the instructions in this manual carefully.

### LOCATION OF DATA PLATE

The data plate is located on the right side panel.

## IMMEDIATELY INSPECT FOR SHIPPING DAMAGE

All containers should be examined for damage before and during unloading. The freight carrier has assumed responsibility for its safe transit and delivery. If equipment is received damaged, either apparent or concealed, a claim must be made with the delivering carrier.



A) Apparent damage or loss must be noted on the freight bill at the time of delivery. It must then be signed by the carrier representative (Driver). If this is not done, the carrier may refuse the claim. The carrier can supply the necessary forms.



B) Concealed damage or loss if not apparent until after equipment is uncrated, a request for inspection must be made to the carrier within 15 days. The carrier should arrange an inspection. Be certain to hold all contents and packaging material.

Installation and start-up should be performed by a qualified installer who thoroughly read, understands and follows these instruction.



If you have questions concerning the installation, operation, maintenance or service of this product, write Technical Service Department Bakers Pride Oven Company, Inc., 30 Pine Street, New Rochelle, NY, 10801.

## SAFETY PRECAUTIONS

 **DANGER:** This symbol warns of imminent hazard which will result in serious injury or death. 



 **WARNING:** This symbol refers to a potential hazard or unsafe practice, which could result in serious injury or death. 



 **CAUTION:** This symbol refers to a potential hazard or unsafe practice, which may result in minor or moderate injury or product or property damage. 



 **NOTICE:** This symbol refers to information that needs special attention or must be fully understood even though not dangerous. 

---

 **NOTICE:** This product is intended for commercial use only. Not for household use. 

 **CAUTION:** These models are designed, built, and sold for commercial use. If these models are positioned so the general public can use the equipment make sure that cautions, warnings, and operating instructions are clearly posted near each unit so that anyone using the equipment will use it correctly and not injure themselves or harm the equipment. 

 **WARNING:** Improper installation, operation, service or maintenance can cause property damage, injury or death. Read and understand these instructions thoroughly before positioning, installing, maintaining or servicing this equipment. 

 **NOTICE:** Local codes regarding installation vary greatly from one area to another. The National Fire Protection Association, Inc., states in its NFPA96 latest edition that local codes are "Authority Having Jurisdiction" when it comes to requirement for installation of equipment. Therefore, installation should comply with all local codes. 

## GENERAL INSTALLATION INSTRUCTIONS

Ensure gas supply and gas type, as shown on unit nameplate agree.

Unit installation must conform with the National Fuel Gas Code, ANSI Z223.1/NFPA 54, the National Gas Installation Code, CSA-B149.1, or the Propane Installation Code, CSA-B149.2 as applicable and in accordance with local codes.

Screw legs into the permanently fastened nuts on the four corners of the unit and tighten by hand. Level the unit by turning the adjustment screw at the bottom of each leg. Do not slide unit with legs mounted, lift if necessary to move unit.

Pipe threading compound must be resistant to the action of liquefied petroleum gases.

**Caution:** DO NOT use an open flame to check for leaks. Check all gas piping for leaks with a soap and water solution before operating unit.

### **THESE UNITS ARE SUITABLE FOR INSTALLATION ON NON-COMBUSTIBLE SURFACES ONLY.**

Noncombustible clearances:

0" sides (0 mm)      0" rear (0 mm)      4" floor (102 mm)

Do not obstruct the flow of combustion and ventilation air, under the unit by the legs or behind the unit by the flue.

Adequate clearance for air openings into the combustion chamber is required. Do not place objects between the bottom of the unit and the counter top.

There must be adequate clearance for removal of the front panel. All major parts except the burners are removable thru the front if the gas line is disconnected.

Unit must have adequate clearances for servicing. (Sides = 0", Rear = 0", Floor = 4").

### **European Community Installation Instructions:**

"THIS APPLIANCE MUST BE FITTED BY A COMPETENT PERSON. IN THE UK, CORGI REGISTERED INSTALLERS (INCLUDING THE REGIONS OF BRITISH GAS) UNDERTAKE TO WORK TO SAFE AND SATISFACTORY STANDARDS. THIS APPLIANCE MUST BE INSTALLED IN ACCORDANCE WITH THE GAS SAFETY (INSTALLATION AND USE) REGULATIONS AND THE RELEVANT BUILDING REGULATIONS / IEE. REGULATIONS. DETAILED RECOMMENDATIONS ARE CONTAINED IN THE FOLLOWING BRITISH STANDARD CODES OF PRACTICE - BS 6172, BS 5440 PART 2, BS 6891"

"THIS APPLIANCE MUST BE INSTALLED IN ACCORDANCE WITH THE RULES IN FORCE"

"MUST BE INSTALLED IN A WELL VENTILATED AREA. Ventilation requirements ie. B.S. 5440."

## SPECIFICATIONS AND DIMENSIONS

MODEL	WIDTH IN. (MM)	DEPTH IN. (MM)	HEIGHT IN. (MM)	# OF BURNERS	BTU/kW PER BURNER NATURAL GAS	TOTAL BTU/kW HOUR	W.C. IN. ('Mbar')
HDCB-2424	24" (609.6)	33.312" (846)	15.217" (386.5)	4	20,000 (5.86)	80,000 (23.4)	5 (12.4)
HDCB-2436	36" (914.4)	33.312" (846)	15.217" (386.5)	6	20,000 (5.86)	120,000 (35.2)	5 (12.4)
HDCB-2448	48" (1219.2)	33.312" (846)	15.217" (386.5)	8	20,000 (5.86)	160,000 (46.9)	5 (12.4)
HDCB-2460	60" (1524.0)	33.312" (846)	15.217" (386.5)	10	20,000 (5.86)	200,000 (58.6)	5 (12.4)
HDCB-2472	72" (1828.8)	33.312" (846)	15.217" (386.5)	12	20,000 (5.86)	240,000 (70.3)	5 (12.4)
HDCRB-2424	24" (609.6)	33.312" (846)	15.217" (386.5)	4	20,000 (5.86)	80,000 (23.4)	5 (12.4)
HDCRB-2436	36" (914.4)	33.312" (846)	15.217" (386.5)	6	20,000 (5.86)	120,000 (35.2)	5 (12.4)
HDCRB-2448	48" (1219.2)	33.312" (846)	15.217" (386.5)	8	20,000 (5.86)	160,000 (46.9)	5 (12.4)
HDCRB-2460	60" (1524.0)	33.312" (846)	15.217" (386.5)	10	20,000 (5.86)	200,000 (58.6)	5 (12.4)
HDCRB-2472	72" (1828.8)	33.312" (846)	15.217" (386.5)	12	20,000 (5.86)	240,000 (70.3)	5 (12.4)

# HDCB & HDCRB-2424, 24" GAS CHAR BROILER

21829500

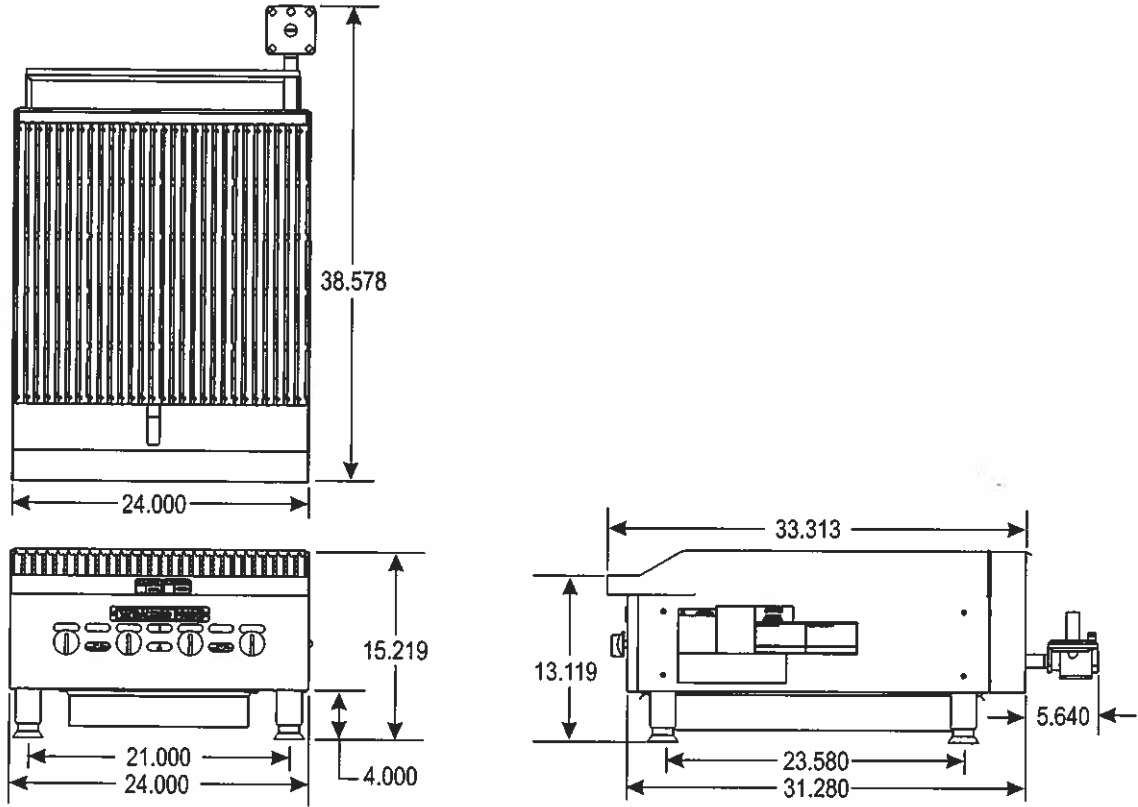

# HDCB & HDCRB-2436, 36" GAS CHAR BROILER

21829600

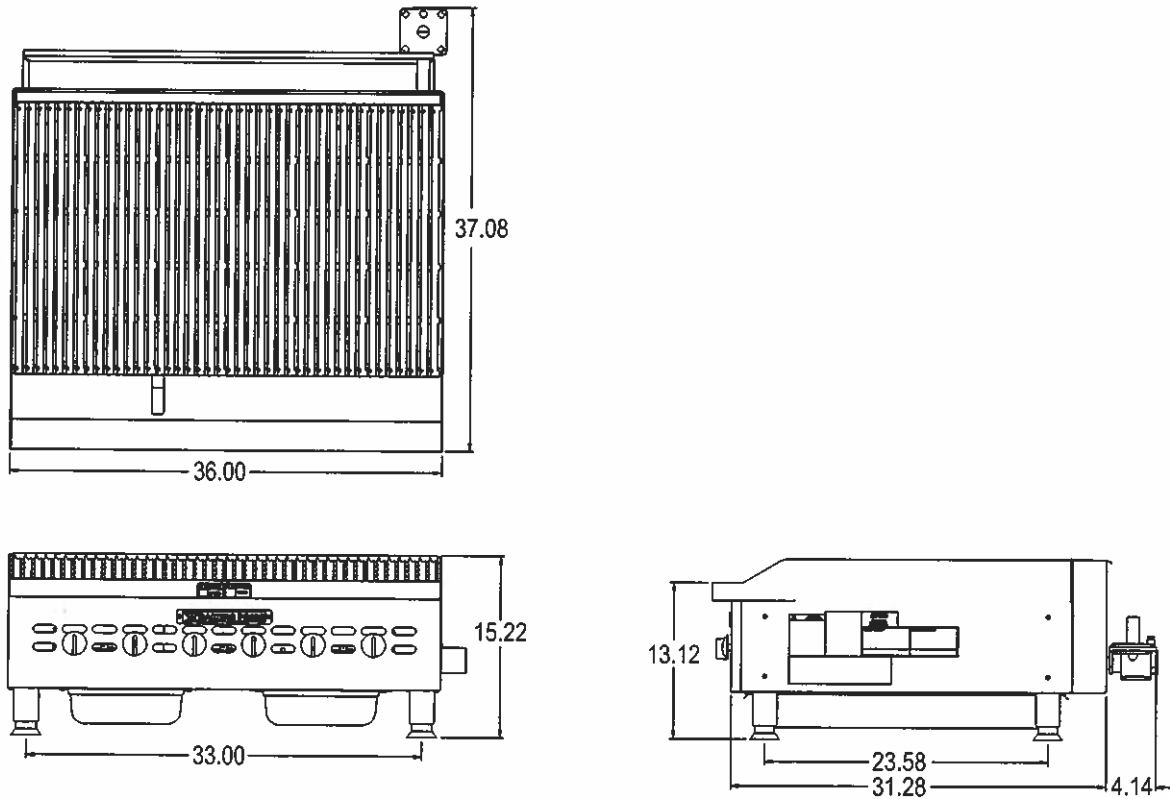

# HDCB & HDCRB-2448, 48" GAS CHAR BROILER

21829700

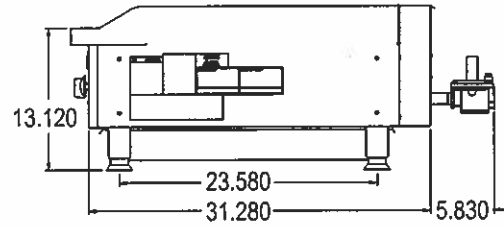
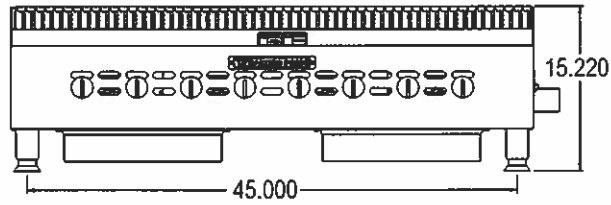
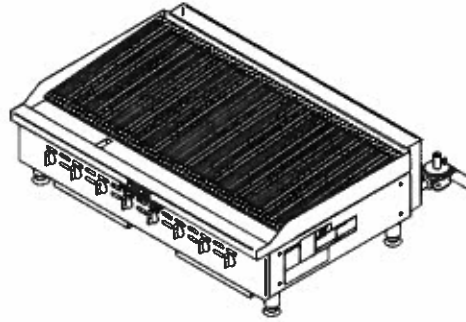
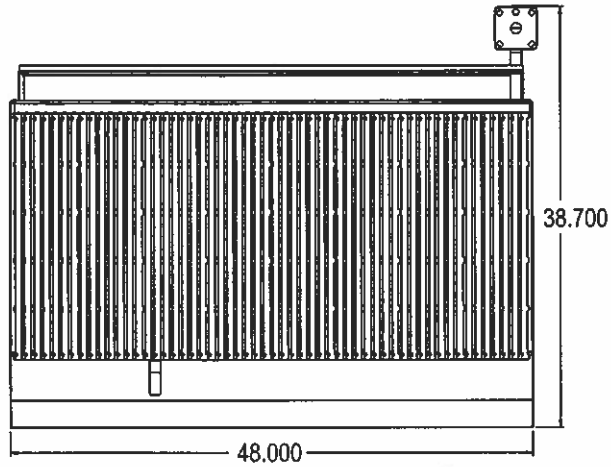

# HDCB & HDCRB-2460, 60" GAS CHAR BROILER

21829800

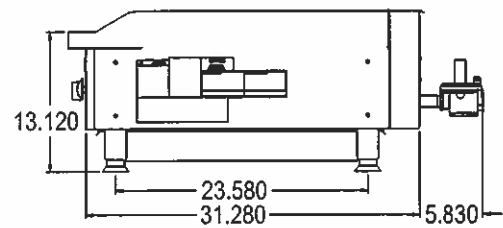
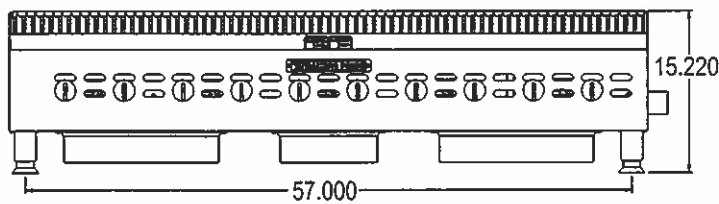
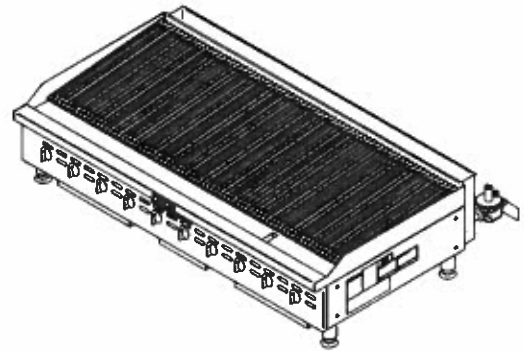
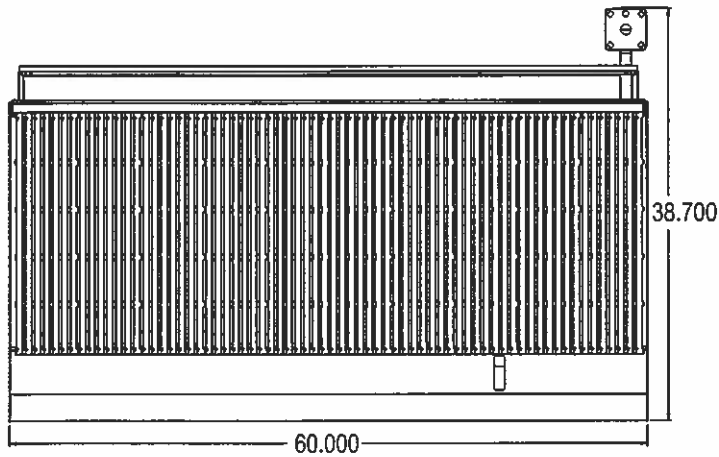

# HDCB & HDCRB-2472, 72" GAS CHAR BROILER

21829900

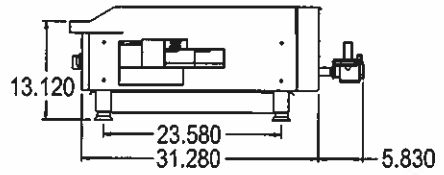
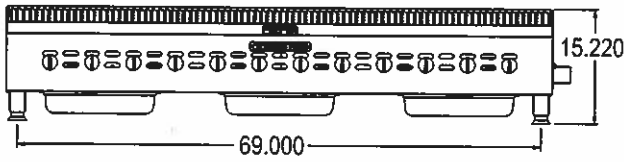
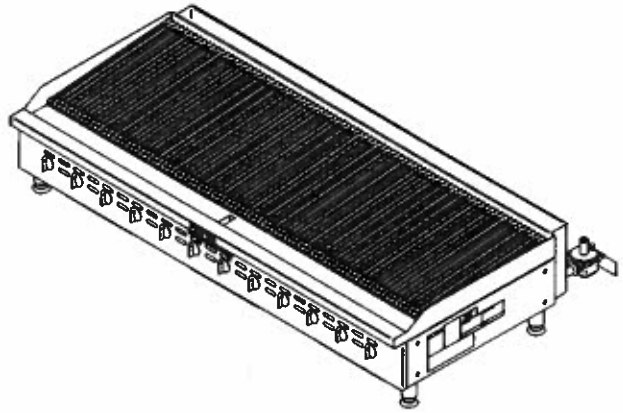
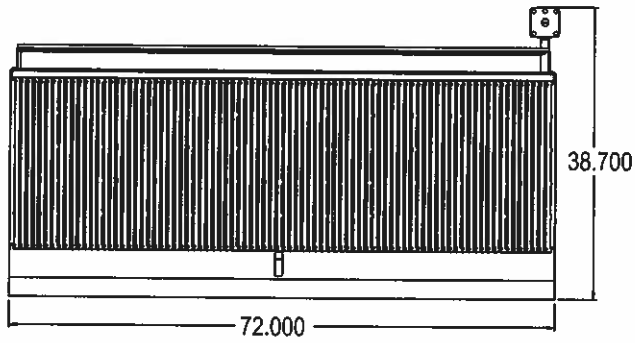

## CONVERSION

- Instructions are for conversion from Natural Gas to Propane (L.P.) on all models HDCRB & HDCB.
- The conversion should be done before connecting the unit to the gas supply.
- Units are shipped from the factory equipped for use on natural gas. Orifices necessary for LP (propane) are provided in a bag tied to the valve on the front panel.
  1. Remove the knobs and front panel.
  2. Remove the orifice fittings from the valve. Change the orifices to the size recommended for propane (L.P.).
  3. Replace the orifice fittings into the valve.
- To change the regulator:

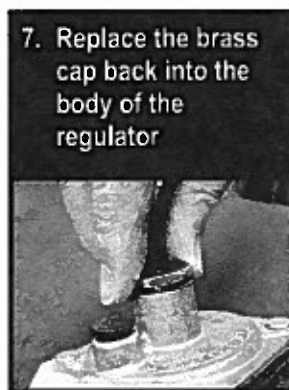
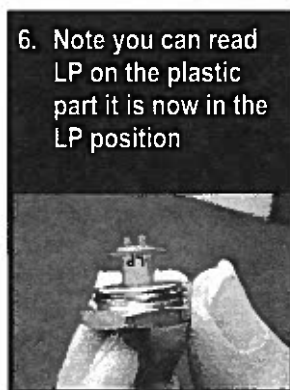
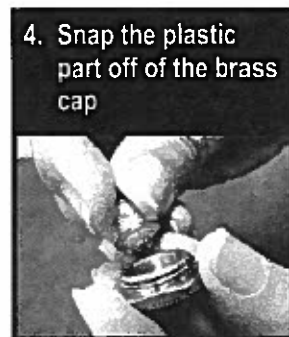
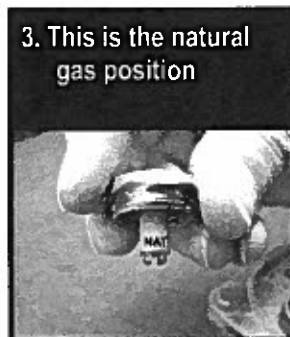
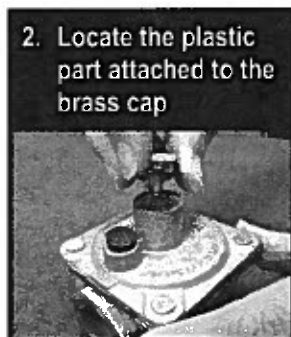

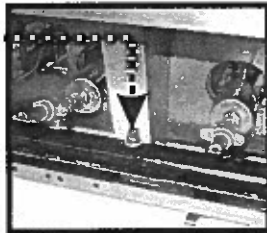
- Connect the regulator to the unit, connect gas and check for leaks. **WARNING:** Do not use an open flame to check for leaks.
- Check the system pressure. With the front panel removed remove the plug-----
- Place a fitting in the plug opening and connect a manometer.
- For Natural gas the pressure in the manifold should be 5" water column or 12.4 millibar. For LP the pressure in the manifold should be 10" water Column of 24.9 millibar.
- To adjust the pressure remove the brass cap and turn the white plastic part inside the stem of the regulator. See picture regulator 8.
- Take a wide straight screw driver and place it in the two notches shown in picture regulator 7 turn clockwise to increase pressure and counter-clockwise to reduce pressure. See picture regulator 8.
- Once the pressure has been adjusted replace the brass cap.
- Note the blue cap on the regulator, this is the vent there are openings below the top rim. **NEVER** block these openings your regulator will fail to operate correctly. On at least a monthly basis blow off any dust or grease which may accumulate around this cap. The openings must remain open for the regulator to function. Clean more often in a very greasy atmosphere.



## LIGHTING INSTRUCTIONS

HDCB and HDCRB Broilers are furnished with either a pilot safety valve or a standing pilot (not available in the European Community). Please follow the instructions for your unit.

### Pilot Operation Flame Failure Gas Valve:

Operation of the gas valve pilot:

- 1 Turn knob on the main gas valve to the pilot position
- 2 Depress knob to start gas flow to the pilot valve
- 3 Light pilot valve
  - a. Using a match or taper
- 4 Hold in knob for 15 to 30 seconds to heat up the thermocouple
- 5 Release knob and turn to the desired gas flow position
  - a. If pilot goes out repeat steps 1-4, some thermocouples will take longer to heat up

### Standing Pilot Lighting Instructions: ( Not Available in the European Community )

The pilot lights on the broilers have been set at the factory. A screwdriver may be required for the first lighting to adjust the flame for your elevation.

- 1 Turn off the manual shut off valve and wait 5 minutes to clear the gas.
- 2 Turn all knobs to the "OFF" position.
- 3 The valve can be accessed through an opening in the front panel or remove the cooking grates and light the pilot from above.
- 4 Turn the manual shut off valve on.
- 5 Hold an ignition source (match) to both openings on the pilot tube. When the flames are established, remove the ignition source.
- 6 Turn the burner knobs to "HI". If the burner does not ignite, promptly open the pilot valve more. If the pilot flame appears larger than necessary, turn it down and reset burner ignition. The pilot flame should be as small as possible but large enough to guarantee reliable ignition of the burners when the knobs are turned to "HI".

### RELIGHTING PILOT

If the pilot light should go out for any reason:

- Promptly shut off all gas at the manual shut off valve.
- Turn off all knobs and pilot valves; wait 5 minutes to clear gas.
- Relight following steps 4 through 6 under **Standing Pilot Lighting Instructions**.

### LIGHTING MAIN BURNER:

Since the burner is lit from constantly burning pilot, turn knobs to "HI" to put the unit in operation; then adjust to any desired position between "LO" and "HI".

- To light burner, turn knob to "max." then back off to the desired flame level. The range of adjustment is virtually infinite between high and off. (At the small flame, there is a pre-set low).
- When the broiler is first heated, it will smoke until oil used in manufacturing, preservation and dust from storage and shipping are burned off. An hour at "max." on all burners is usually sufficient.
- Turn knobs off and let cool
- For first cooking, set the grates at maximum tilt position and preheat before broiling. You will have to experiment with knob settings and grate position for each particular item.
- Keep the grease/water pan with sufficient water to cover the entire bottom.
- Clean regularly. Grates may be removed for washing in the sink. Brush out carbonized particles. Thoroughly wash the grease/water pan.

### CAUTION

Never attempt to move a grill section while cooking. An unexpected flare could cause severe injury. Turn off the unit, let it cool and use potholders and/or gloves to reposition or remove. The space between the legs at the bottom admits combustion air. **DO NOT BLOCK THIS SPACE.**

**Main burner air supply:**

For efficient burner operation, a proper balance of gas volume and primary air supply must be maintained which will result in complete combustion. Insufficient air supply results in a yellow streaming flame. Primary air supply is controlled by an air shutter on the front of the burner.

Loosen the screws on the front of the burner, and adjust the air shutter to just eliminate the yellow tips of the burner flame. Lock the air shutter in place by tightening the screws.

**European Community:**

**If adjustment becomes necessary in the field, it should be done by a factory authorized and trained technician who should seal the screw after the adjustment to safeguard against un-authorized tampering by the end user.**

All burners are lit from constantly burning pilots. Turning the valve to the desired flame height is all that is required to put the unit in service.

Do not permit fans to blow directly at the unit. Wherever possible, avoid open windows next to the units' sides or back. Avoid wall type fans which create air cross-currents within a room.

It is also necessary that sufficient air should be allowed to enter the room to compensate for the amount of air removed by any ventilating system. Otherwise, a subnormal atmospheric pressure will occur, affecting operation and causing undesirable working conditions.

A properly designed and installed hood will act as the heart of the ventilating system for the room or area in which the unit is installed, and will leave the unit independent of changing draft conditions.

All valves must be checked and lubricated periodically. This must be done by an authorized service representative in your area.

## OPERATING INSTRUCTIONS

**OPERATION:** Turn the burners on about 15-20 minutes before cooking for preheating. Set the knobs to the desired flame height or temperature. Each valve will control the gas flow to the burner to bring that area of the unit up to the set temperature. If different temperature settings are to be used, adjoining areas should be set at progressively higher temperatures using the lowest temperatures on the outside burners. A uniform and systematic approach to the loading of the unit will produce the most consistent product results.

**RADIANTS**

Place the radiants in their position as shown in Sketch 1. Make sure that the radiants are setting properly into the slots on the front and rear supports. Radiants should be centered over straight section of the burners.

**COOKING GRATES**

Place the top cooking grates with the grid bars sloping toward the front as shown in Sketch 2.

**SEASON GRIDDLE**

Heat to low temperature (300 - 350 F/150-180C) and pour on a small amount of cooking oil, about one ounce (30cc) per square foot of surface. Spread the oil over the entire griddle surface with a cloth to create a thin film. Wipe off any excess oil with a cloth. Repeat this procedure 2 to 3 times until the griddle has a slick, mirror-like surface.

**NOTE:** When cooking grates are placed sloping toward the front, the grooves on top will guide the excess fat drippings into the grease trough. For wider branding marks turn the cooking grate over so the product is placed on the wider rails. There is less grease removal with the cooking grates in this position so there will be a little more flare ups in this position.



**CAUTION:** Do not turn on gas valves without lighting the pilots. This could cause a build up of gas and potential explosion.



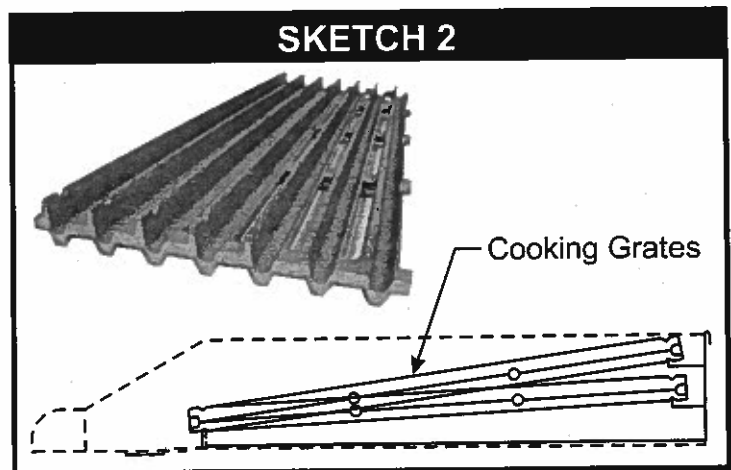
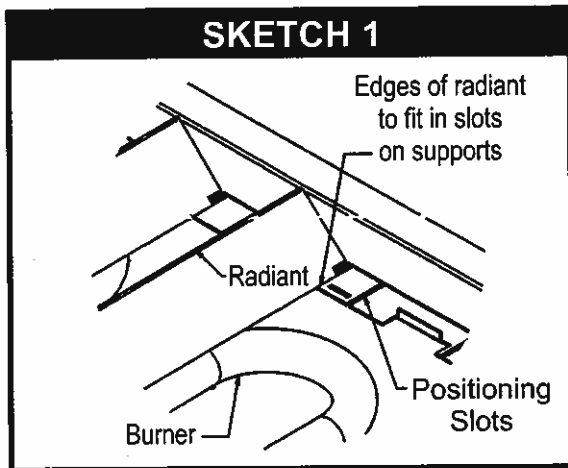

## CLEANING / MAINTENANCE

### INITIAL CLEANING:

Prior to operating your new broiler, thoroughly wash the exterior with a mild detergent or soap solution. Do not use abrasive cleaners, since this might damage the cabinet finish. If the stainless steel surfaces become discolored, scrub by rubbing only in the direction of the finished grain.

When the broiler is first heated, it will smoke until oil used in manufacturing, preservation and dust from storage and shipping are burned off. An hour at "max." on all burners is usually sufficient.

### CLEANING:

#### DAILY

Remove the grease pan, empty and wash it.

Grate "burn off". The grease buildup on the grates should be cleaned daily (more often as needed).

- A. **Caution:** When handling grates or radiants, always use insulated gloves to prevent burns.
- B. **Warning:** Do not cover the top of the grid grates during a burn off operation. Restricting the airflow by covering the grid grates may cause them to warp. It will also cause damage to the valves, the knobs, the rock grates and the front panel decal.
- C. Place grates on broiler, with grid bars horizontal, facing down.
- D. Turn control knobs to "HI" for approximately 45 minutes.
- E. Turn off the broiler and allow it to cool for 20 Minutes.
- F. Clean top and bottom surfaces of grate with a wire brush to remove animal fats and carbonized grease.
- G. Clean channels on grates with a scraper.
- H. Remove grates from broiler. Clean top surface of radiants with the wire brush. They may be cleaned in place.

#### WEEKLY

Thoroughly clean the exposed surfaces of broiler, sides, front and top grease trough, with a damp cloth, then polish with a soft, dry cloth. A detergent may be used for cleaning. To remove discoloration, use a non-abrasive cleaner.

After performing daily cleaning procedures, proceed with the following:

- A. Remove the radiants or rock grates. Clean reflecting drip shield of any dust or debris with a brush.  
**Note:** Top cooking grates and rock grates are heavy. For applications where you use abundant sauces, radiants and rock grates should be cleaned more often.
- B. Burner air shutter openings must be kept clean.
- C. Burner ports must be kept clean. To clean burners, boil them in a strong solution of lye water for fifteen to twenty minutes. Then, either brush with a wire brush or clean gas ports with a sharp-pointed metal instrument to insure open ports.



**CAUTION:** Clean the regulator at least once a month. Make sure the vent opening is open and not blocked in any way. Failure to do so will cause variations in pressure. Your unit will not function as well and it could shorten the life of the product.



**EXTENDED SHUTDOWN:**

Turn the manual shutoff valve to "OFF"; (\*field installed valve not supplied by the manufacturer), turn all control knobs to the "OFF" position and shut off the pilot flame by turning the adjustment on the pilot valve.

\*NOTE: Gas shutoff valve is supplied by the manufacturer on CE or European Community models.

**SERVICE / REPAIR**

**NOTE: THIS APPLIANCE MUST ONLY BE SERVICED BY AN AUTHORIZED AGENT.**

**NOTE:** Parts protected by the manufacturer or his agent are not to be adjusted by the installer, unless the installer is an authorized service agent.

**TROUBLESHOOTING GUIDE**

PROBLEM	POSSIBLE CAUSE
Heat does not come on when valve is turned on.	Pilot burner not lit.
	Gas valve is bad.
Pilot burner will not light.	Obstructed pilot orifice.
	Pilot gas turned off at automatic pilot.
	Automatic pilot valve is bad.
	Gas is shut off to unit.
Pilot burner will not stay lit.	Thermocouple is bad.
	Thermocouple is not hot enough.
	Obstructed or wrong size pilot orifice.
	Gas supply is not purged of air.
	Air is blowing pilot light out.
Fat appears to smoke excessively.	Automatic pilot valve is bad.
	Heat is set too high.
Food sticks to grates.	Moisture in the food may be turning into steam.
	Heat is set too high.
	Griddle surface needs cleaning and/or seasoning.
Food is undercooked inside.	Surface under food may not have been covered with enough cooking oil.
	Heat is set too high.
Food tastes greasy or has objectionable off-flavor.	Food may not have been cooked for long enough time.
	Food itself may have off flavor.
	Food may have been stored improperly before cooking.
	Too much griddle fat used.
	Heat is set too low.

**PLACE LAVA ROCKS OR GLO STONES WITH AIR SPACES BETWEEN THE ROCKS. DO NOT OVER**

Please use the following amount of lava rocks or glo stones per model.

- HDCRB 24" = Approximately 6 LBS.
- HDCRB 36" = Approximately 9 LBS.
- HDCRB 48" = Approximately 12 LBS.
- HDCRB 60" = Approximately 15 LBS.
- HDCRB 72" = Approximately 18 LBS.



# EXPLODED VIEW (Domestic Version)

## HDCB & HDCRB - GAS CHAR BROILER

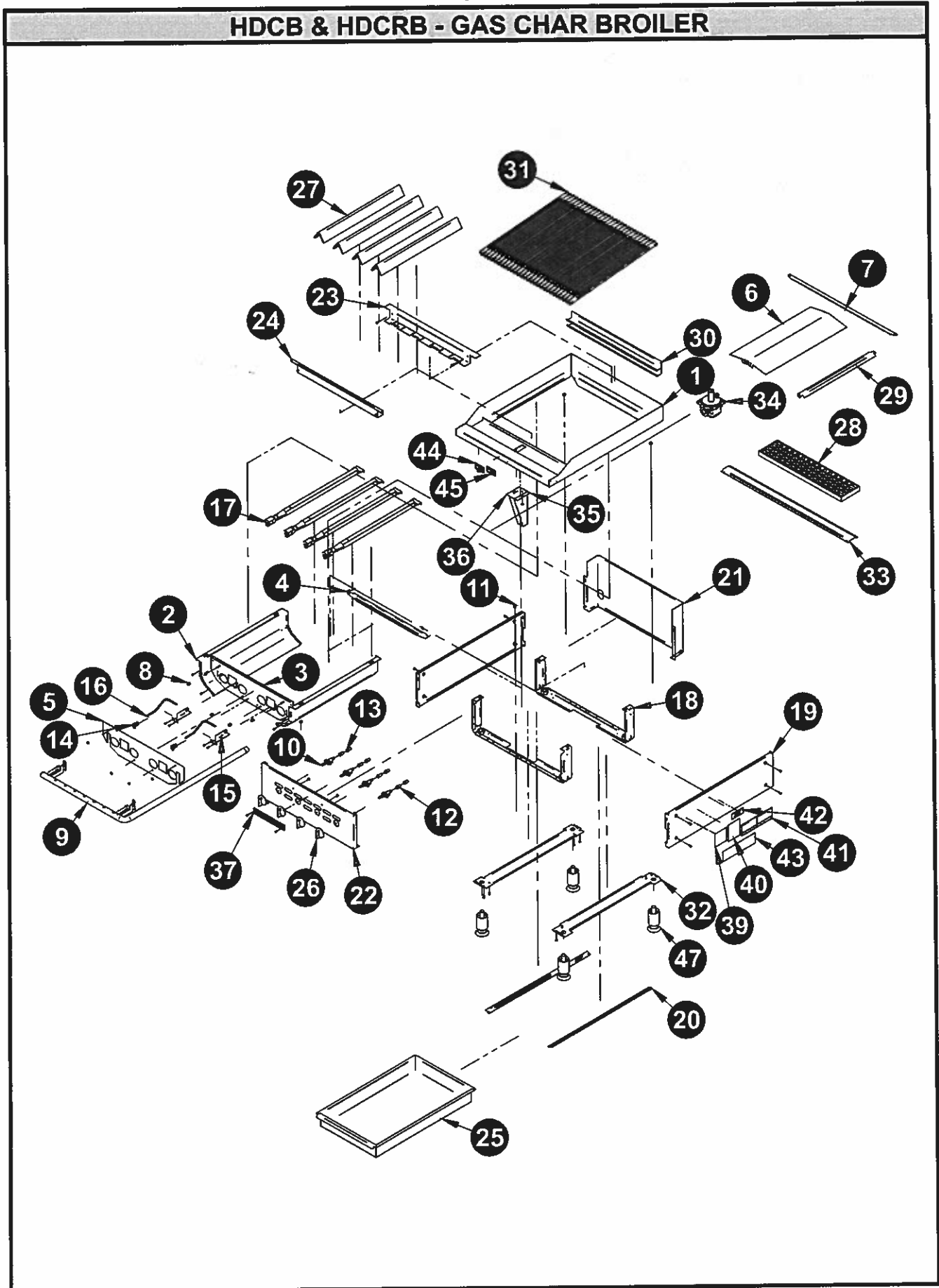

## PARTS LIST (DOMESTIC VERSION)

HDCB & HDCRB - GAS CHAR BROILER (Page 1 of 2)												
Item	P/N	Description	Quantity									
			HDCB-2424	HDCRB-2424	HDCB-2436	HDCRB-2436	HDCB-2448	HDCRB-2448	HDCB-2460	HDCRB-2460	HDCB-2472	HDCRB-2472
1	21829520	Weldm't, Bullnose	1	1								
	2182620	Weldm't, Bullnose			1	1						
	21829720	Weldm't, Bullnose					1	1				
	21829820	Weldm't, Bullnose							1	1		
	21829920	Weldm't, Bullnose									1	1
2	21825433	Side, Firebox	2	2	2	2	2	2	2	2	2	2
3	21825022	Body, 24" Firebox	1	1								
	21825122	Body, 36" Firebox			1	1						
	21825222	Body, 48" Firebox					1	1				
	21825322	Body, 60" Firebox							1	1		
4	21825422	Body, 72" Firebox									1	1
	21825017	Support, Burner	1	1								
	21825117	Support, Burner			1	1						
	21825216	Support, Burner					1	1				
	21825316	Support, Burner							1	1		
5	21825416	Support, Burner									1	1
	21825027	Baffle, Front Heat	1	1								
	21825127	Baffle, Front Heat			1	1						
	21825227	Baffle, Front Heat					1	1				
	21825327	Baffle, Front Heat							1	1		
6	21825427	Baffle, Front Heat									1	1
	21825134	Divider, Firebox	NA	NA	1	1	1	1	2	2	2	2
7	21825126	Support, Firebox	NA	NA	1	1						
	21825217	Support, Firebox					1	1				
	21825317	Support, Firebox							1	1		
8	21825417	Support, Firebox									1	1
	21813085	Spacer	4	4	4	4	5	5	5	5	6	6
9	21829525	Manifold, 24"	1	1								
	21829625	Manifold, 36"			1	1						
	21829725	Manifold, 48"					1	1				
	21829825	Manifold, 60"							1	1		
	21829925	Manifold, 72"									1	1
10	2068500	Valve, Gas, On-Off	4	4	6	6	8	8	10	10	12	12
11	2092517	Plug, 1/8 NPTM	1	1	1	1	1	1	1	1	1	1
12	2066845	Hood, Orifice #45	4	4	6	6	8	8	10	10	12	12
13	2066855	Hood, Orifice #55	4	4	6	6	8	8	10	10	12	12
14	2068001	Valve, Pilot 90°	2	2	3	3	4	4	5	5	6	6
15	21825113	Bracket, Pilot	2	2	3	3	4	4	5	5	6	6
16	21829612	Tube, Pilot	2	2	3	3	4	4	NA	NA	NA	NA
	21829913	Tube, Pilot	NA	NA	NA	NA	NA	NA	5	5	6	6
17	2065845	Burner, Tube Hvy Dty	4	4	6	6	8	8	10	10	12	12
18	21825053	Support, Leg 24"	2	2								
	21825153	Support, Leg 36"			2	2						
	21825253	Support, Leg 48"					2	2				
	21825353	Support, Leg 60"							2	2		
	21825453	Support, Leg 72"									2	2
19	21825054	Panel, Right & Left Side	2	2	2	2	2	2	2	2	2	2
20	21825011	Guide, Grease Slide	2	2	4	4	4	4	6	6	6	6
21	21825032	Panel, Back 24"	1	1								
	21825132	Panel, Back 36"			1	1						
	21825232	Panel, Back 48"					1	1				
	21825332	Panel, Back 60"							1	1		
	21825432	Panel, Back 72"									1	1
22	21829519	Panel, Control 24"	1	1								
	21829619	Panel, Control 36"			1	1						
	21829719	Panel, Control 48"					1	1				

## HDCB & HDCRB - GAS CHAR BROILER (Page 2 of 2)

Item	P/N	Description	Quantity										
			HDCB-2424	HDCRB-2424	HDCB-2436	HDCRB-2436	HDCB-2448	HDCRB-2448	HDCB-2460	HDCRB-2460	HDCB-2472	HDCRB-2472	
23	21829819	Panel, Control 60"							1	1			
	21829919	Panel, Control 72"									1	1	
	21825028	Support, Rock Grate Rear	1	1									
	21825128	Support, Rock Grate Rear			1	1							
	21825228	Support, Rock Grate Rear					1	1					
24	21825328	Support, Rock Grate Rear							1	1			
	21825428	Support, Rock Grate Rear									1	1	
	21825029	Support, Rock Grate Front	1	1									
	21825129	Support, Rock Grate Front			1	1							
	21825229	Support, Rock Grate Front					1	1					
25	21825329	Support, Rock Grate Front							1	1			
	21825429	Support, Rock Grate Front									1	1	
	2425210	Pan, Grease 18"	NA	NA	2	2	NA	NA	1	1	NA	NA	
26	2425310	Pan, Grease 24"	1	1	NA	NA	2	2	2	2	3	3	
	8706400	Knob, Metal Cookline .375 D Shaft	4	4	6	6	8	8	10	10	12	12	
27	21825016	Radiant, S/S	4		6		8		10		12		
	2065844	Radiant, Cast (Optional) (N/S)	4		6		8		10		12		
28	3102210	Grate, Rock Hvy Dty		4		6		8		11		13	
	21825018	Guard, Burner		4		6		8		10		12	
31	21813129	Weldm't, Grate Support	1	1									
	21813229	Weldm't, Grate Support			1	1							
	21813329	Weldm't, Grate Support					1	1					
	21825334	Weldm't, Grate Support							1	1			
	21825434	Weldm't, Grate Support									1	1	
32	3103900	Grate, Cooking Hvy Dty	4	4	6	6	8	8	10	10	12	12	
	21825031	Brace, Leg	2	2	2	2	2	2	2	2	2	2	
	33	21826134	Channel, Stiffener	NA	NA	1	1						
		21826234	Channel, Stiffener					1	1				
		21826334	Channel, Stiffener							1	1		
21826434	Channel, Stiffener									1	1		
34	2067600	Regulator, 5" W.C. & 10" W.C.	1	1	1	1	1	1	1	1	1	1	
	21825024	Side, Grease Chute	1	1	1	1	1	1	1	1	1	1	
	21825026	Side, Grease Chute Left	1	1	1	1	1	1	1	1	1	1	
	8808900	Nameplate, 8" Bakers Pride	1	1	1	1	1	1	1	1	1	1	
	3100300	Brickquets, Ceramic (N/S)	20LBS	20LBS	30LBS	30LBS	40LBS	40LBS	50LBS	50LBS	60LBS	60LBS	
39	310000	Lava, Rock 8lb Bag (Optional) (N/S)		1		2		2		3		3	
	8861000	Label, Spec	1	1	1	1	1	1	1	1	1	1	
	8809920	Decal, Improper Installation	1	1	1	1	1	1	1	1	1	1	
	8837109	Label, Orifice Size	1	1	1	1	1	1	1	1	1	1	
	8825300	Decal, Leg	1	1	1	1	1	1	1	1	1	1	
43	8837130	Decal, Operating Instructions	1	1	1	1	1	1	1	1	1	1	
	43813103	Label, Hot Surface	1	1	1	1	1	1	1	1	1	1	
	43813149	Label, Hot Surface (French)	1	1	1	1	1	1	1	1	1	1	
	8835300	Inst/Op Manual (N/S)	1	1	1	1	1	1	1	1	1	1	
	47	8633700	Leg, 2" Dia. Hvy Dty	4	4	4	4	4	4	4	4	4	4

# EXPLODED VIEW (CE Version)

## HDCB & HDCRB - GAS CHAR BROILER

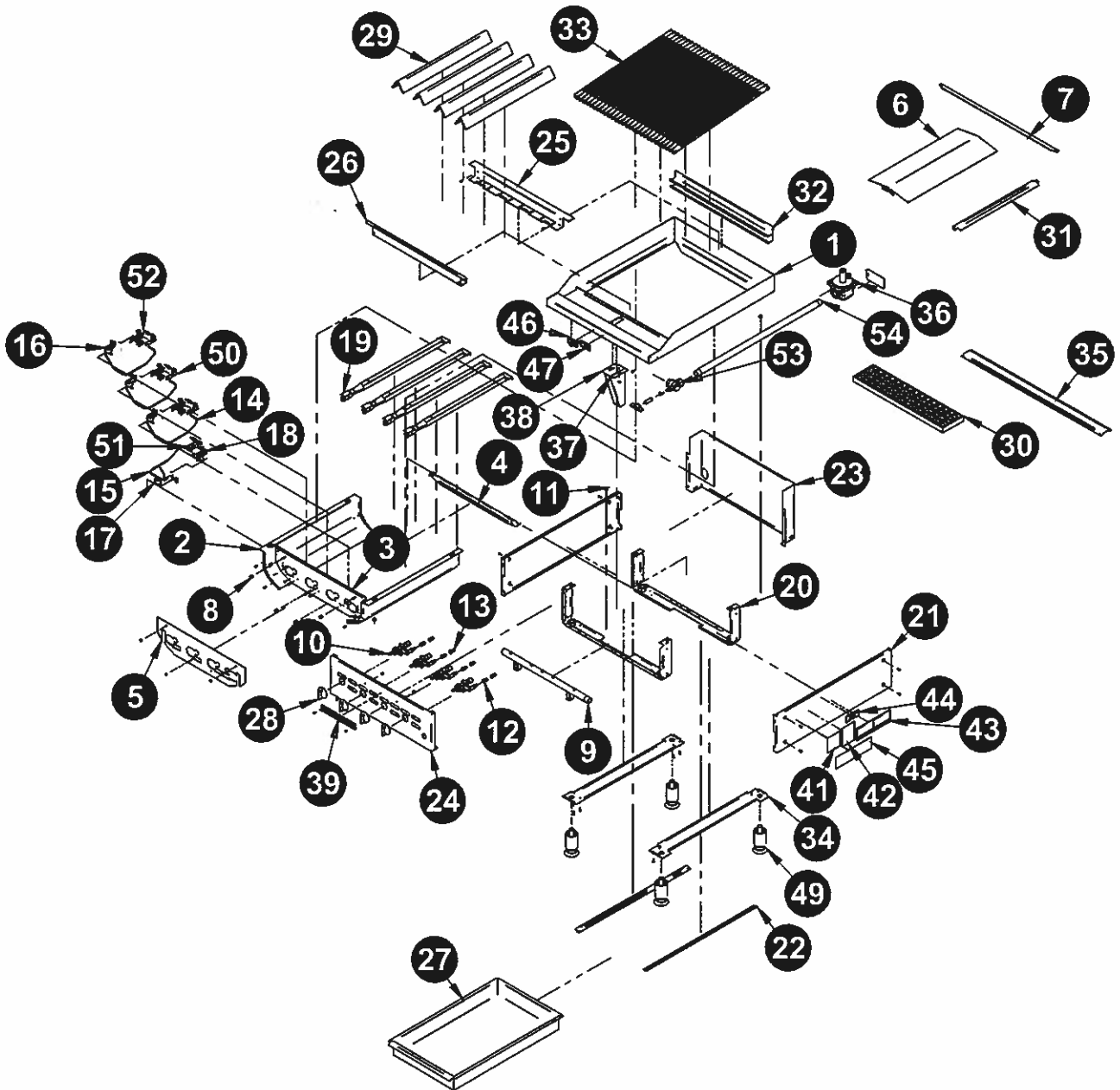



## PARTS LIST (CE VERSION)

HDCB & HDCRB - GAS CHAR BROILER (Page 1 of 2)															
Item	P/N	Description	Quantity												
			HDCB-2424	HDCRB-2424	HDCB-2436	HDCRB-2436	HDCB-2448	HDCRB-2448	HDCB-2460	HDCRB-2460	HDCB-2472	HDCRB-2472			
1	21829520	Weldm't, Bullnose	1	1											
	2182620	Weldm't, Bullnose			1	1									
	21829720	Weldm't, Bullnose					1	1							
	21829820	Weldm't, Bullnose							1	1					
	21829920	Weldm't, Bullnose									1	1			
2	21825433	Side, Firebox	2	2	2	2	2	2	2	2	2	2	2	2	2
3	21825036	Face, 24" Firebox CE	1	1											
	21825136	Face, 36" Firebox CE			1	1									
	21825236	Face, 48" Firebox CE					1	1							
	21825338	Face, 60" Firebox CE							1	1					
4	21825438	Face, 72" Firebox CE											1	1	
	21825017	Support, Burner	1	1											
	21825117	Support, Burner			1	1									
	21825216	Support, Burner					1	1							
	21825316	Support, Burner							1	1					
5	21825416	Support, Burner											1	1	
	21825037	Baffle, Front Heat CE	1	1											
	21825137	Baffle, Front Heat CE			1	1									
	21825237	Baffle, Front Heat CE					1	1							
	21825339	Baffle, Front Heat CE							1	1					
6	21825439	Baffle, Front Heat CE											1	1	
7	21825134	Divider, Firebox	NA	NA	1	1	1	1	2	2			2	2	
	21825126	Support, Firebox	NA	NA	1	1									
	21825217	Support, firebox					1	1							
	21825317	Support, Firebox							1	1					
8	21825417	Support, Firebox											1	1	
9	21813085	Spacer	4	4	4	4	5	5	5	5			6	6	
	21829535	Manifold, 24" CE	1	1											
	21829635	Manifold, 36" CE			1	1									
	21829735	Manifold, 48" CE					1	1							
	21829835	Manifold, 60" CE							1	1					
	21829935	Manifold, 72" CE											1	1	
10	2068300	Valve, Gas, On-Off CE	4	4	6	6	8	8	10	10			12	12	
11	2092517	Plug, 1/8 NPTM	1	1	1	1	1	1	1	1			1	1	
12	2066845	Hood, Orifice #45	4	4	6	6	8	8	10	10			12	12	
13	2066855	Hood, Orifice #55	4	4	6	6	8	8	10	10			12	12	
14	21829718	Tube, Pilot Supply CE	3	3	5	5	7	7	9	9			11	11	
15	21829739	Tube, Pilot Supply CE Reverse	1	1	1	1	1	1	1	1			1	1	
16	21825446	Bracket, Pilot CE	3	3	5	5	7	7	9	9			11	11	
17	21825447	Bracket, Pilot CE Long	1	1	1	1	1	1	1	1			1	1	
18	20932100	Pilot, Burner	4	4	6	6	8	8	10	10			12	12	
19	2065845	Burner, Tube Hvy Dty	4	4	6	6	8	8	10	10			12	12	
20	21825053	Support, Leg 24"	2	2											
	21825153	Support, Leg 36"			2	2									
	21825253	Support, Leg 48"					2	2							
	21825353	Support, Leg 60"							2	2					
21	21825453	Support, Leg 72"											2	2	
	21825054	Panel, Right & Left Side	2	2	2	2	2	2	2	2			2	2	
22	21825011	Guide, Grease Slide	2	2	4	4	4	4	6	6			6	6	
23	21825032	Panel, Back 24"	1	1											
	21825132	Panel, Back 36"			1	1									
	21825232	Panel, Back 48"					1	1							
	21825332	Panel, Back 60"							1	1					
	21825432	Panel, Back 72"											1	1	
24	21829541	Panel, Control 24" CE	1	1											
	21829641	Panel, Control 36" CE			1	1									

## HDCB & HDCRB - GAS CHAR BROILER (Page 2 of 2)

Item	P/N	Description	Quantity									
			HDCB-2424	HDCRB-2424	HDCB-2436	HDCRB-2436	HDCB-2448	HDCRB-2448	HDCB-2460	HDCRB-2460	HDCB-2472	HDCRB-2472
25	21829741	Panel, Control 48" CE					1	1				
	21829841	Panel, Control 60" CE							1	1		
	21829941	Panel, Control 72" CE									1	1
	21825028	Support, Rock Grate Rear	1	1								
	21825128	Support, Rock Grate Rear			1	1						
26	21825228	Support, Rock Grate Rear					1	1				
	21825328	Support, Rock Grate Rear							1	1		
	21825428	Support, Rock Grate Rear									1	1
	21825029	Support, Rock Grate Front	1	1								
	21825129	Support, Rock Grate Front			1	1						
27	21825229	Support, Rock Grate Front					1	1				
	21825329	Support, Rock Grate Front							1	1		
	21825429	Support, Rock Grate Front									1	1
	2425210	Pan, Grease 18"	NA	NA	2	2	NA	NA	1	1	NA	NA
	2425310	Pan, Grease 24"	1	1	NA	NA	2	2	2	2	3	3
28	8706400	Knob, Metal Cookline .375 D Shaft	4	4	6	6	8	8	10	10	12	12
29	21825016	Radiant, S/S	4		6		8		10		12	
	2065844	Radiant, Cast (Optional) (N/S)	4		6		8		10		12	
30	3102210	Grate, Rock Hvy Dty		4		6		8		11		13
31	21825018	Guard, Burner		4		6		8		10		12
32	21813129	Weldm't, Grate Support	1	1								
	21813229	Weldm't, Grate Support			1	1						
	21813329	Weldm't, Grate Support					1	1				
	21825334	Weldm't, Grate Support							1	1		
	21825434	Weldm't, Grate Support									1	1
33	3103900	Grate, Cooking Hvy Dty	4	4	6	6	8	8	10	10	12	12
34	21825031	Brace, Leg	2	2	2	2	2	2	2	2	2	2
35	21826134	Channel, Stiffener	NA	NA	1	1						
	21826234	Channel, Stiffener					1	1				
	21826334	Channel, Stiffener							1	1		
	21826434	Channel, Stiffener									1	1
36	2067600	Regulator, 5" W.C. & 10" W.C.	1	1	1	1	1	1	1	1	1	1
37	21825024	Side, Grease Chute	1	1	1	1	1	1	1	1	1	1
38	21825026	Side, Grease Chute Left	1	1	1	1	1	1	1	1	1	1
39	8808900	Nameplate, 8" Bakers Pride	1	1	1	1	1	1	1	1	1	1
40	3100300	Brickquets, Ceramic (N/S)	20LBS	20LBS	30LBS	30LBS	40LBS	40LBS	50LBS	50LBS	60LBS	60LBS
	310000	Lava, Rock 8lb Bag (Optional) (N/S)		1		2		2		3		3
41	8861000	Label, Spec	1	1	1	1	1	1	1	1	1	1
42	8809920	Decal, Improper Installation	1	1	1	1	1	1	1	1	1	1
43	8837109	Label, Orifice Size	1	1	1	1	1	1	1	1	1	1
44	8825300	Decal, Leg	1	1	1	1	1	1	1	1	1	1
45	8837130	Decal, Operating Instructions	1	1	1	1	1	1	1	1	1	1
46	43813103	Label, Hot Surface	1	1	1	1	1	1	1	1	1	1
47	43813149	Label, Hot Surface (French)	1	1	1	1	1	1	1	1	1	1
48	8835300	Inst/Op Manual (N/S)	1	1	1	1	1	1	1	1	1	1
49	8633700	Leg, 2" Dia. Hvy Dty	4	4	4	4	4	4	4	4	4	4
50	21826016	Bracket, Thermocouple	3	3	5	5	7	7	9	9	11	11
51	21826011	Bracket, Thermocouple Reverse	1	1	1	1	1	1	1	1	1	1
52	1473700	Thermocouple, CE 600mm	4	4	6	6	8	8	10	10	12	12
53	2069700	Valve, Shut Off 90°	1	1	1	1	1	1	1	1	1	1
54	2092626	Pipe, Inlet	1	1	1	1	1	1	1	1	1	1
55	8806070	Label, Delivery CE Gas Units (N/S)	1	1	1	1	1	1	1	1	1	1
56	8806075	Label, Packaging CE Units (N/S)	1	1	1	1	1	1	1	1	1	1
57	8806080	Label, CE Ventilation (N/S)	1	1	1	1	1	1	1	1	1	1



## BAKERS PRIDE LIMITED WARRANTY

30 Pine Street New Rochelle, New York 10801  
914 / 576 - 0200 ♦ US & Canada: 1 - 800 - 431 - 2745 ♦ fax 914 / 576 - 0605

- WHAT IS COVERED** This warranty covers defects in material and workmanship under normal use, and applies only to the original purchaser providing that:
- ♦ The equipment has not been accidentally or intentionally damaged, altered or misused;
  - ♦ The equipment is properly installed, adjusted, operated and maintained in accordance with National and local codes, and in accordance with the installation instruction provided with the product;
  - ♦ The serial number rating plate affixed to the equipment has not been defaced or removed.
- WHO IS COVERED** This warranty is extended to the original purchaser and applies only to equipment purchased for use in the U.S.A.
- COVERAGE PERIOD** Full size gas and electric deck ovens: Two (2) year limited parts and labor; Cyclone Convection Ovens: BCO Models: One (1) Year limited parts and labor; GDCO Models: Two (2) Year limited parts and labor; CO II Models: Two (2) Year limited parts and labor; (5) Year limited door warranty.  
All Other Products: One (1) Year limited parts and labor.  
Warranty period begins the date of dealer invoice to customer or ninety (90) days after shipment date from BAKERS PRIDE - whichever comes first.
- WARRANTY COVERAGE** This warranty covers on-site labor, parts and reasonable travel time and travel expenses of the authorized service representative up to (100) miles, round trip, and (2) hours travel time. The purchaser, however, shall be responsible for all expenses related to travel, including time, mileage and shipping expenses on smaller counter models that may be carried into a Factory Authorized Service Center, including the following models: PX-14, PX-16, P18, and BK-18.
- EXCEPTIONS** All removable parts in BAKERS PRIDE Char-broilers, including but not limited to: Burners, Grates, Radiants, Stones and Valves, are covered for a period of SIX MONTHS.  
All Ceramic Baking Decks are covered for a period of THREE MONTHS. The installation of these replacement decks is the responsibility of the purchaser.  
The extended Cyclone door warranty years 3 through 5 is a parts only warranty and does not include labor, travel, mileage or any other charges.
- EXCLUSIONS**
- ♦ Negligence or acts of God,
  - ♦ Thermostat calibrations after (30) days from equipment installation date,
  - ♦ Air and Gas adjustments,
  - ♦ Light bulbs,
  - ♦ Glass doors and door adjustments,
  - ♦ Fuses,
  - ♦ Char-broiler work decks and cutting boards,
  - ♦ Tightening of conveyor chains,
  - ♦ Adjustments to burner flames and cleaning of pilot burners,
  - ♦ Tightening of screws or fasteners,
  - ♦ Failures caused by erratic voltages or gas supplies,
  - ♦ Unauthorized repair by anyone other than a BAKERS PRIDE Factory Authorized Service Center,
  - ♦ Damage in shipment,
  - ♦ Alteration, misuse or improper installation,
  - ♦ Thermostats and safety valves with broken capillary tubes,
  - ♦ Accessories - spatulas, forks, steak turners, grate lifters, oven brushes, scrapers, peels, etc.,
  - ♦ Freight - other than normal UPS charges,
  - ♦ Ordinary wear and tear.
- INSTALLATION** Leveling and installation of decks, as well as proper installation and check out of all new equipment - per appropriate installation and use materials - is the responsibility of the dealer or installer, not the manufacturer.
- REPLACEMENT PARTS** BAKERS PRIDE genuine Factory OEM parts receive a (90) day materials warranty effective from the date of installation by a BAKERS PRIDE Factory Authorized Service Center.

This Warranty is in lieu of all other warranties, expressed or implied, and all other obligations or liabilities on the manufacturers part. BAKERS PRIDE shall in no event be liable for any special, indirect or consequential damages, or in any event for damages in excess of the purchase price of the unit. The repair or replacement of proven defective parts shall constitute a fulfillment of all obligations under the terms of this warranty.

Form #U4177A 1/07



---

**BAKERS PRIDE OVEN CO., INC.**  
30 Pine Street  
New Rochelle, NY 10801

(914) 576-0200 Phone  
(914) 576-0605 Fax

(800) 431-2745 US & Canada  
[www.bakerspride.com](http://www.bakerspride.com) WebAddress