



# **KLT-G Series**

## **GAS FIRED TRI-LEG TILTING KETTLE**

### **INSTALLATION – OPERATION – MAINTENANCE**



**BLODGETT OVEN COMPANY**

[www.blodgett.com](http://www.blodgett.com)  
44 Lakeside Avenue, Burlington, Vermont 05401 USA Telephone (800) 331-5842, (802) 860-3700 Fax: (802) 864-0183

S00052 Rev A (5/04)

It is recommended that this manual be read thoroughly and that all instructions be followed carefully.



**This is the safety alert symbol. It is used to alert you to potential personal injury hazards. Obey all safety messages that follow this symbol to avoid possible injury or death.**



**FOR YOUR SAFETY: Do not store or use gasoline or other flammable vapors or liquids in the vicinity of this or any other appliance.**



**WARNING: Improper installation, operation, adjustment, alteration, service or maintenance can cause property damage, injury or death. Read the installation, operating and maintenance instructions thoroughly before installing, operating or servicing this equipment.**

**PURCHASER: Instructions to be followed in the event that the operator of this appliance smells gas must be posted in a prominent location. This information shall be obtained by consulting the local gas supplier.**

**Do not obstruct the flow of combustion and ventilation air.  
Keep the appliance area free and clear from combustibles.  
Adequate clearances must be maintained for servicing and proper operation.**

**Do not attempt to operate this unit in the event of a power failure.**





**Intended for commercial use only. Not for household use.**

**This manual should be retained for future reference.**

## TABLE OF CONTENTS

| <b>DESCRIPTION</b>                             | <b>PAGE</b> |
|--|-------------|
| Important Notes For Installation and Operation | 2           |
| 1.0 Service Connections                        | 4           |
| 2.0 Installation                               | 5           |
| 3.0 Operation                                  | 10          |
| 4.0 Cleaning Instructions                      | 16          |
| 5.0 Maintenance                                | 20          |
| 6.0 Service                                    | 21          |
| 7.0 Troubleshooting                            | 26          |
| Appendix A, Material Safety Data Sheet         | 29          |

## 1.0 SERVICE CONNECTIONS

-  Supply gas through 3/4" pipe . A gas shut-off valve must be installed in supply piping convenient and adjacent to appliance.
-  Unless other wise specified, Field Wire Electrical Connection to be 120 Volts, 60 Hertz single phase with grounding wire.
-  COLD WATER: 3/8"(10mm) tubing to faucet (OPTIONAL)
-  HOT WATER: 3/8"(10mm) tubing to faucet (OPTIONAL)

| MODEL   | GAS SUPPLY |        |   |
|---------|------------|--------|---|
|         | BTU/HR.    | KW/HR. | SUPPLY PIPE PRESSURE (W.C.)                                       |
| KLT-20G | 80,000     | 23.4   | Natural<br>6"-14" (152-356mm)      Propane<br>11"-14" (279-356mm) |
| KLT-40G | 100,000    | 29.3   |   |
| KLT-60G | 120,000    | 35.2   |   |

### DIMENSIONS

| MODEL   | CAPACITY   | UNITS  | A   | B     | C     | D     | E     | F    | G    | H     | J   | K   | L    | M     | N    |
|---------|------------|--------|-----|-------|-------|-------|-------|------|------|-------|-----|-----|------|-------|------|
| KLT-20G | 20 gallons | inches | 20  | 48.13 | 40.63 | 19    | 40.13 | 76.5 | 16.5 | 24    | 11  | 22  | 40.5 | 18.38 | 25.5 |
|         | 76 litres  | mm     | 508 | 1222  | 1032  | 483   | 1019  | 1943 | 419  | 610   | 279 | 559 | 1029 | 467   | 648  |
| KLT-40G | 40 gallons | inches | 26  | 55.25 | 43.63 | 16.5  | 43.25 | 76   | 15.5 | 22.25 | 7.5 | 23  | 42.5 | 22.13 | 28.5 |
|         | 152 litres | mm     | 660 | 1403  | 1108  | 419   | 1099  | 1930 | 394  | 565   | 191 | 584 | 1080 | 562   | 724  |
| KLT-60G | 60 gallons | inches | 30  | 59    | 45.63 | 17.88 | 43.88 | 82   | 19.5 | 22.25 | 5.5 | 23  | 45.5 | 24.75 | 30.5 |
|         | 227 litres | mm     | 762 | 1499  | 1159  | 454   | 1115  | 2083 | 495  | 565   | 140 | 584 | 1156 | 629   | 775  |

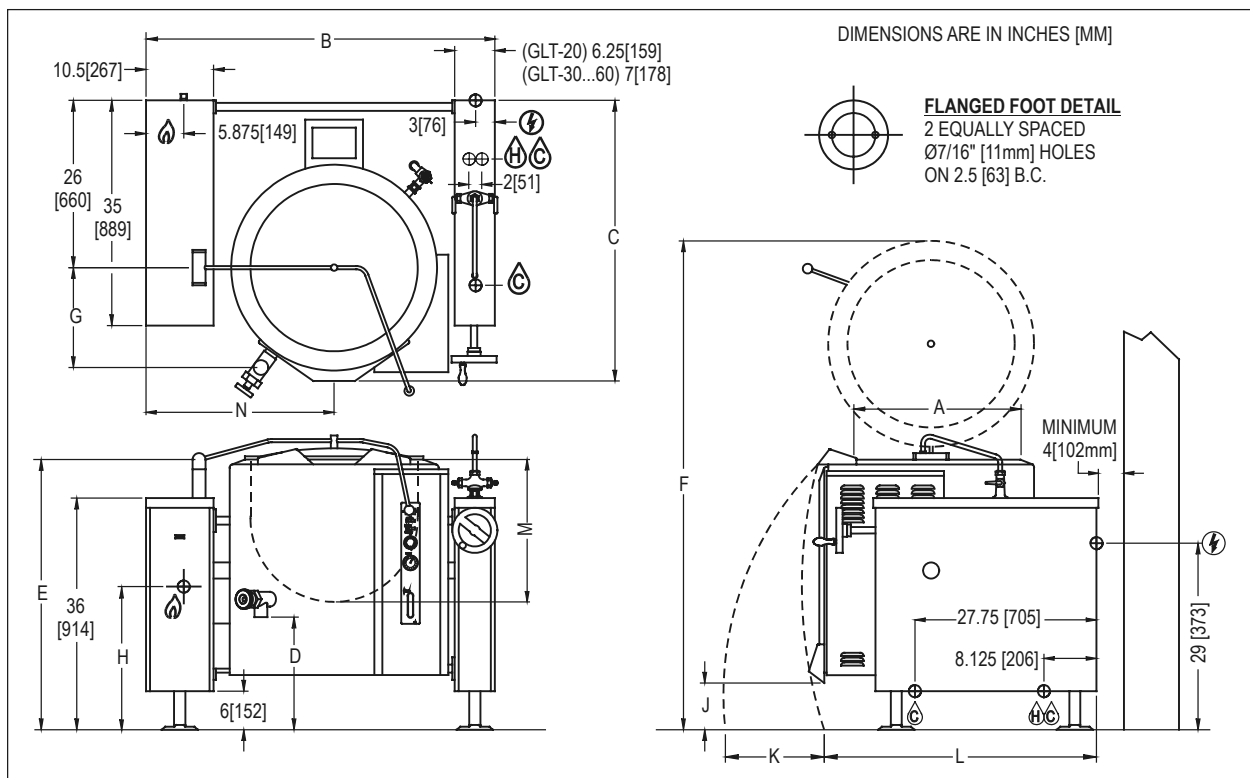

## **2.0 INSTALLATION**

### **INSTALLATION CODES AND STANDARDS**

Installation must conform with local codes, or in the absence of local codes, with the *National Fuel Gas Code, ANSI Z223.1/NFPA 54*, or the *Natural Gas and Propane Installation Code, CSA B149.1*, as applicable.

1. The appliance and its individual shut off valve must be disconnected from the gas supply piping system during any pressure testing of that system at pressures in excess of ½ psi (3.5 kPa).
2. The appliance must be isolated from the gas supply piping system by closing its individual manual shut off valve during any pressure testing of the gas supply piping system at test pressures equal to or less than ½ psi (3.5 kPa).

Electrical grounding must be provided in accordance with local codes, or in the absence of local codes, with the National Electrical Code, ANSI/NFPA 70, or the Canadian Electrical Code, CSA C22.2, as applicable.

The electrical diagram is located on the inside of side panel of left hand console.

**EXHAUST FANS AND CANOPIES:** Canopies are set over ranges, ovens and kettles for ventilation purposes. It is recommended that a canopy extend 6 inches past appliance and be located 7.5 feet from the floor. Filters should be installed at an angle of 45 degrees or more with the horizontal. This position prevents dripping of grease and facilitates collecting the run-off grease in a drip pan, usually installed with the filter. A strong exhaust fan tends to create a vacuum in the room and may interfere with burner performance or may extinguish pilot flames. Makeup air openings approximately equal to the fan area will relieve such vacuum. In case of unsatisfactory performance on any appliance, check operation with exhaust fan in the "OFF" position.

**WALL EXHAUST FAN:** The exhaust fan should be installed at least two feet above the vent opening at the top of the unit.

**CLEARANCES:** Adequate clearance must be provided in aisle and at the side and back. Adequate clearances for air openings into the combustion chamber must be provided, as well as for serviceability.

|                 |                             |
|-----------------|-----------------------------|
| <b>SIDES -</b>  | <b>0 INCHES</b>             |
| <b>BACK -</b>   | <b>4 INCHES AT FLUE BOX</b> |
| <b>FLOORS -</b> | <b>NON-COMBUSTIBLE</b>      |

## **INSTALLATION (Continued)**

All units must be installed in such a manner that the flow of combustion and ventilation air are not obstructed. Provisions for an adequate air supply must also be provided. Do not obstruct side of the unit, as combustion air enters through this area.

Information on the construction and installation of ventilating hoods may be obtained from the standard for "Vapor Removal from Cooking Equipment", NFPA No. 96 (latest edition), available from the National Fire Protection Association, Batterymarch Park, Quincy, MA, USA, 02269.

## **TO INSTALL**

1. Uncrate carefully. Report any hidden freight damage to the freight company immediately.
2. The pressure relief valve is located at the right rear of the unit. This area should be kept clear and should not be in an area where operators will normally stand. The elbow on the relief valve should be turned toward the floor. A maximum 3 foot, 3/4" diameter pipe may be used to extend to the floor, but must not be piped directly to a drain. It must vent to the atmosphere.
3. Set the unit in place. Be certain to maintain minimum clearances as stated above.
4. To level the unit use a spirit level in all directions on the top of the kettle (lid up). Adjust the bottom foot on each leg to overcome an uneven floor.
5. Mark hole locations on floor through anchoring holes provided in flanged adjustable feet.
6. Remove appliance and drill holes in locations marked on floor and insert proper anchoring devices.
7. Set unit back in position and re-level left to right and front to back.
8. Bolt and anchor appliances securely to the floor.
9. Seal bolts and flanged feet with silastic or equivalent compound.
10. Appliance location must allow air supply to unit and obstruction free clearance for air opening into the combustion chamber.
11. Make service connections as indicated.
12. Check the pressure gauge on the front panel before operating. If the pressure gauge does not indicate green vacuum zone (below 0 psi), see "Re-establishing Vacuum" section under SERVICE, after completing installation instructions.

## 2.0 INSTALLATION (Continued)

### GAS CONNECTION

The serial plate on the lower right side of the unit indicates the type of gas your unit is equipped to burn. Do **NOT** connect to any other gas type.

A 3/4" NPT line is provided at the rear for the connection. Each unit is equipped with an internal pressure regulator which is set for 3.5" W.C. manifold pressure for natural gas and 4.0" W.C. for propane gas. Use 1/8" pipe tap on the downstream side of the combination valve for checking pressure.

An adequate gas supply is imperative. Undersized or low pressure lines will restrict the volume of gas required for satisfactory performance. A steady pressure, minimum 6" W.C. for natural gas and minimum 11" W.C. for propane gas, is recommended. With all units operating simultaneously, the manifold pressure on all units should not show any appreciable drop. Fluctuations of more than 25% on natural gas, and 10% on propane gas, will create pilot problems and affect burner operating characteristics. Contact your gas company for correct supply line sizes.

Purge the supply line to clean out any dust, dirt, or other foreign matter before connecting the line to the unit. It is recommended that an individual manual shut off valve be installed in the gas supply line to the unit. Use pipe joint compound which is suitable for use with LP gas on all threaded connections. Test pipe connections thoroughly for gas leaks.



**WARNING:** All connections must be checked for leaks, after the unit has been put in operation. Use soapy water only for testing on all gases. Never use an open flame to check for gas leaks.

**NOTICE:** If applicable, the vent line from the gas appliance pressure regulator shall be installed to the outdoors in accordance with local codes or, in the absence of local codes, with the *National Fuel Gas Code, ANSI Z223.1/NFPA 54*, or the *Natural Gas and Propane Installation Code CSA B149.1*, as applicable.

**NOTICE:** If this equipment is being installed at over 2,000 feet altitude and was not so specified on order, contact service department. Failure to install with proper orifice sizing may void the warranty.

## 2.0 INSTALLATION (Continued)

### WATER CONNECTION

On units equipped with an optional water fill valve connect a water line (minimum 1/4") to the valve with a 1/4" NPT female fitting. Units with dual (hot and cold) valves must have the hot water line connected to side with the hot water valve (red) and cold water line to the cold water valve (blue). Plastic or rubber hose is not recommended, as it may melt against the hot kettle side.

### ELECTRICAL CONNECTION

|   |  |
|---|--|
|  | <b>WARNING:</b> Do not connect the kettle to the electrical supply until after the gas connection has been made. |
|---|--|

1. 120 VAC - 60 Hz - Single Phase

|  |  |
|--|--|
|  | <b>WARNING: ELECTRICAL GROUNDING INSTRUCTIONS</b><br>This appliance is equipped with a three-prong (grounding) plug for your protection against shock hazard and should be plugged directly into a properly grounded three-prong receptacle. Do not cut or remove the grounding prong from this plug. (120V units only). |
|--|--|

Units with this electrical rating are factory supplied with a three-wired cord and three-prong plug which fits any standard 120V, three-prong grounded receptacle. A separate 15 amp supply is needed for each unit.

1. 208/240 VAC - 60 Hz - Single and Three Phase

Units with this electrical rating are factory equipped with a transformer. To connect supply wires, remove cover from right console. Route supply wires and ground wire through the hole in the console with a strain relief fitting. Connect wires to the terminal block in the rear of the right console. Connect ground wire to lug. Replace cover. Three-phase units are wired as above, using only two supply wires. The third supply wire is not connected and must be properly terminated.

1. 220 VAC - 50 Hz - Single Phase

Units equipped with this voltage ratings should be wired exactly as in (2.) above.



## **2.0 INSTALLATION (Continued)**

### **PERFORMANCE CHECK**

The following items should be checked before or within the first 30 days of operation by a qualified service technician.

1. Verify correct gas type against rating plate on unit.
2. Verify correct voltage, cycle and phase against rating plate on unit.
3. Gas pressure.
4. Internal gas connections.
5. Internal electrical connections.
6. Burners - adjustment and ignition.
7. Thermostat - cycle for operation check.
8. Gas supply valve - check for operation.
9. Check hinge and lid assembly.
10. Draw-off valve - check operation.
11. Advise user on cleaning procedure.

### 3.0 OPERATION

Contact the factory, the factory representative or a local service company to perform maintenance and repairs should the appliance malfunction.



**CAUTION:** If you smell gas during the lighting procedure, immediately shut off the gas supply until the leak has been corrected.



**WARNING:** In the event of main burner ignition failure, a 5 minute purge period must be observed prior to re-establishing ignition source.



**WARNING:** In the event you smell gas, shut down equipment at the main shut off valve and contact the local gas company or gas supplier for service.

### GAS CONTROL INSTRUCTIONS

The units do not require “lighting” the pilot with a match.

#### **A. Lighting**

**NOTE:** Unit is shipped with gas combination valve turned “on”.

1. Open manual gas shut off valve.
2. Set thermostat to OFF, and kettle in fully upright position, turn power switch ON.
3. Set thermostat to maximum, initiating a 30 second pre-purge. Red “COOKING” pilot will come on, and after 30 seconds, the green “IGNITION” pilot will come on, lighting the main burners.

### **3.0 OPERATION** (Continued)

#### **A. Lighting** (Continued)

If after 36 seconds the burner fails to ignite or the “ignition light goes out, the system goes into Safety Lockout. De-energize the system by setting the thermostat to “OFF” for five minutes and try again.

1. Set the thermostat to desired temperature setting. When temperature setting has been reached, the “IGNITION” pilot will go off, turning off the burner. The unit will then cycle on and off to maintain set temperature.

**NOTE: When the kettle is tilted a safety switch will automatically turn off gas supply. The kettle will not operate once it has been tilted.**

#### **DAILY SHUTDOWN**

1. Turn power switch “OFF.”
2. Turn thermostat “OFF.”

#### **COMPLETE SHUTDOWN**

1. Turn power switch “OFF.”
2. Turn thermostat “OFF”.
3. Turn power supply to unit “OFF”.
4. Remove front access panel on left side and turn dial on combination valve to “OFF”.
5. Close manual gas shut off valve.

### **3.0 OPERATION (Continued)**

#### **FRONT PANEL CONTROLS**

##### **POWER SWITCH**

This switch turns the main power to the unit on and off. It must be turned on to heat the kettle. It should be turned off when the kettle will not be in use for long periods.

##### **(GREEN) IGNITION LIGHT**

This light is on whenever the main burner gas is on.

##### **(RED) COOKING LIGHT**

This light is on when the thermostat is calling for heat.

##### **(AMBER) LOW WATER LIGHT**

All kettles are supplied with sufficient distilled water in pressurized jacket. If at any time the water level falls below that required for proper operation, the kettle will not heat and this light will come on. See "Adding Water" in Service section.

### 3.0 OPERATION (Continued)

#### **THERMOSTAT**

The thermostat selects the desired internal kettle operating temperature. The thermostat must be set at a desired setting in order for the burner to ignite.

For Reference:

| <u>DIAL SETTING</u> | <u>°C</u> | <u>°F</u> |
|---------------------|-----------|-----------|
| 1                   | 15        | 60        |
| 2                   | 27        | 81        |
| 3                   | 40        | 104       |
| 4                   | 53        | 127       |
| 5                   | 67        | 153       |
| 6                   | 81        | 178       |
| 7                   | 95        | 203       |
| 8                   | 108       | 226       |
| 9                   | 122       | 252       |
| 10                  | 135       | 275       |

#### **PRESSURE GAUGE**

The pressure gauge indicates the internal operating pressure of the kettle. When cold, the gauge should point to the green vacuum zone. If it does not, refer to “Re-establishing Vacuum” section. Under normal operation with the kettle empty (thermostat set at 10 or 275°F) the pressure should reach 30 psi. When loaded the pressure may be considerably less.

#### **SIGHT GLASS**

The sight glass indicates the minimum and maximum water level within the kettle. If water level falls below minimum level more distilled water should be added. See “Adding Water” in Service section.

### **3.0 OPERATION** (Continued)

#### **PRESSURE RELIEF VALVE**

The pressure relief valve is a safety device which prevents the internal kettle pressure from exceeding 50 psi. It should never be tampered with.

#### **DAILY OPERATION**

Daily operation should consist of turning on the power switch and setting thermostat for the desired temperature.

It is recommended the kettle be preheated prior to use. Milk or egg based products should be placed in the kettle before heating however, to prevent sticking. The kettle is preheated when the cooking light goes off the first time.

At the end of the day, or if the kettle will not be used for some time, shut the unit down by turning the power switch to "OFF".

Clean as required or on a daily basis. See "CLEANING INSTRUCTIONS" section.

#### **END USE TIPS**

For easier cleaning add cold water to the kettle immediately after removing contents.

When preparing foods containing vinegar or tomatoes, or those which have a high salt content, clean the kettle immediately after using to prevent pitting.

Do not use salt to clean the kettle. This will scratch the surface.

If using salt water to cook shellfish, be sure to rinse and wash the kettle thoroughly after use.

Bring milk and egg products slowly up to temperature in a cold kettle to prevent product from adhering to the sides. When preparing milk-based products do not preheat the kettle.

When planning actual cooking capacity, allow room at top for stirring without spilling.

When preparing puddings from a mix, place the powder in a cold kettle, add a small amount of liquid, and stir to form a thin paste. Turn on the kettle and add the remainder of the liquid. Continue as per recipe instructions.

When browning meat, bring the kettle up to temperature before adding. This will seal the juices in the meat.

### 3.0 OPERATION (Continued)

#### GAS SAVING TIPS

Use these reminders to help develop energy-saving procedures and habits. Using less natural or propane gas saves energy as well as money.

1. Turn off when not in use.
2. Limit preheat times.
3. Use lid when possible.
4. Maintain equipment.

#### 4.0 CLEANING INSTRUCTIONS

|   |  |
|---|--|
|  | <b>WARNING:</b> Disconnect the power supply to the appliance before cleaning or servicing. |
|---|--|

|   |   |
|---|---|
|  | <b>WARNING:</b> Never spray water into electric controls or components! |
|---|---|

|   |   |
|---|---|
|  | <b>CAUTION:</b> The equipment and its parts are hot. Use care when operating, cleaning and servicing. |
|---|---|

|  |  |
|--|--|
|  | <b>CAUTION:</b> Do not use cleaning agents that are corrosive. |
|--|--|

Your kettle should be cleaned immediately after each use or when cooking a different product. Before cleaning, check that the kettle has cooled enough to touch it.

1. Rinse the inside of the kettle thoroughly and drain to remove any food particles.
2. Using a nylon brush, clean the kettle with a mild detergent and water. Never use steel wool or scouring powder as it will scratch stainless steel. Plain steel wool can leave small pieces of steel which can rust.
3. Rinse the inside of the kettle thoroughly with clean water. Drain the kettle by tilting or the tangent draw-off valve, depending on model, to allow the detergent and water solution to drain.
4. Wipe the exterior of the kettle with a clean, damp cloth.

|   |   |
|---|---|
|  | <b>WARNING:</b> If you are cleaning a valve that is assembled to a kettle, be sure the kettle is <u>completely empty of any product</u> . |
|---|---|



#### **4.0 CLEANING INSTRUCTIONS** (Continued)

##### **DRAW-OFF VALVE CLEANING**

1. If equipped with a tangent draw-off valve, turn the large hex nut on the draw-off valve counterclockwise until it is completely disengaged from the threads. Grasp the valve knob and slowly pull out the valve stem and disk. Do not allow the disk to come in contact with hard surfaces as it can be damaged and cause valve leakage. Wash the valve stem, disk and handle. Insert a nylon brush, wet with detergent and water, into the valve body and tangent draw-off tube. Brush vigorously.
2. Replace the valve stem assembly and turn the hex nut until snug. Rinse the kettle with clean warm water.
3. Leave the draw-off valve open when the kettle is not in use.

##### **DAIRY DRAW-OFF VALVE CLEANING**

1. Remove the plug by first removing the handle, then turn the plug to line up with the pin and pull with both hands. It is important to use both hands because the plug is heavy.
2. Put the plug in a plastic pail that contains a mild soap solution. A plastic pail works best, as it reduces the possibility of nicking or scratching the plug. If the plug gets scratched it may not seal correctly and could leak.
3. Use a soft cloth or soft brush and clean all surfaces.
4. Using both hands remove the valve from the soap and rinse well in another plastic pail that contains fresh water.
5. Wash out the kettle as normal.
6. Once the kettle is washed out, return the plug into the body. Be sure the plug is inserted into the notch and turned. Ensure the plug is tight and secure before letting go of it.

If you are cleaning a body and plug assembly, remove the plug and follow the above procedures. When finished with the plug, follow the same instructions for washing the body. Always use both hands when handling the plugs. Reassemble the plug into the body and use as normal.

#### 4.0 CLEANING INSTRUCTIONS (Continued)

**NOTICE:** Draw-off valve has a vulcanized rubber coated stem for better sealing. Do not over tighten. This may cause the rubber to pull away from stem and permanently damage it. This is not covered under warranty.

#### WHAT TO DO IF SURFACE RUST APPEARS

Metal utensils should never be used as they will scratch the surface of the equipment and rust may begin to form. To remove surface accumulation of rust from the inadvertent use of such utensils, the following procedure may be used.



**CAUTION:** Improper use of this procedure may damage your appliance!

1. Use undiluted white vinegar with a non-abrasive scouring pad (plastic) or cloth on the affected area to remove the rust stain. The appliance should not be heated and remain at room temperature during the entire cleaning process.
2. If the stain resists removal, additional exposure time with vinegar may be required, to a maximum of one hour.
3. Thoroughly wash all of the vinegar away with fresh clear water. Dry the surface completely and allow one hour before using the appliance to cook.

Following daily and period maintenance procedures will prolong the life for your equipment. Climatic conditions - salt air - may require more thorough and frequent cleaning or the life of the equipment could be adversely affected.

#### STAINLESS STEEL

To remove normal dirt, grease or product residue from stainless steel, use ordinary soap and water (with or without detergent) applied with a sponge or cloth. Dry thoroughly with a clean cloth. Never use vinegar or any other corrosive cleaner.

To remove grease and food splatters or condensed vapours that have baked on the equipment, apply cleanser to a damp cloth or sponge and rub cleanser on the metal in the direction of the polishing lines. Rubbing cleanser as gently as possible in the direction of the polished lines will not mar the finish of the stainless steel. **NEVER RUB WITH A CIRCULAR MOTION.**

#### **4.0 CLEANING INSTRUCTIONS** (Continued)

Soil and burn deposits which do not respond to the above procedure can usually be removed by rubbing the surface with **SCOTCH-BRITE™** scouring pads or **STAINLESS** scouring pads. **DO NOT USE ORDINARY STEEL WOOL** as any particles left on the surface will rust and further spoil the appearance of the finish. **NEVER USE A WIRE BRUSH, STEEL SCOURING PADS (EXCEPT STAINLESS), SCRAPER, FILE OR OTHER STEEL TOOLS.** Surfaces which are marred collect dirt more rapidly and become more difficult to clean. Marring also increases the possibility of corrosive attack. Refinishing may then be required.

**TO REMOVE HEAT TINT:** Darkened areas sometimes appear on stainless steel surfaces where the area has been subjected to excessive heat. These darkened areas are caused by thickening of the protective surface of the stainless steel and is not harmful. Heat tint can normally be removed by the foregoing, but tint which does not respond to this procedure calls for a vigorous scouring in the direction of the polish lines using **SCOTCH-BRITE™** scouring pads or a **STAINLESS** scouring pad in combination with a powdered cleanser. Heat tint action may be lessened by not applying or by reducing heat to equipment during slack periods.

All food contact surfaces must be thoroughly drained and flushed prior to cooking in the kettle.

**CONTROL PANEL:** The textured control panel should be cleaned with warm water and mild soap. Never use an abrasive cloth or steel wool. Never use cleaning solvents with a hydrocarbon base.

## 5.0 MAINTENANCE

Contact the factory, the factory representative or a local service company to perform maintenance and repairs.



**WARNING:** Disconnect the power supply to the appliance before cleaning or servicing.

### **Daily:**

1. Wash exposed cleanable areas.

### **Monthly:**

1. Blower wheel inlet and motor air vent should be cleansed if an accumulation of dust or lint is obvious.

### **Twice a Year: (minimum)**

1. Have an authorized service person clean and adjust the unit for maximum performance.
2. The unit venting system should be examined and cleaned.
3. Grease the screw jack tilt mechanism via the lubricating nipple. Use Petro-Canada type OG-2 or equivalent.

### **Annually:**

1. Have an authorized service person inspect the screw jack assembly for wear. The screw must be replaced immediately if the end play has reached 0.019" [0.5mm].

## **6.0 SERVICE**

### **GENERAL**

When any difficulty arises always check that the unit has been connected to the gas supply type and voltage for which it was supplied. This can be done by examining the serial plate on the lower right side of the unit. It will list the gas type and voltage for which the unit was manufactured.

Wiring diagrams for the unit are located in a small envelope affixed to the side panel of left hand console.

| Unit    | Total Input      | Orifice Size     |                  |
|---------|------------------|------------------|------------------|
|         |                  | Natural          | Propane          |
| KLT-20G | 80,000 BTU/Hour  | DMS # 19 (.166") | DMS # 30 (.125") |
| KLT-40G | 100,000 BTU/Hour | DMS # 13 (.185") | DMS # 27 (.144") |
| KLT-60G | 120,000 BTU/Hour | DMS # 7 (.201")  | DMS # 23 (.154") |

### **MANIFOLD PRESSURE**

Natural Gas - 3.5 inches W.C.

LP Gas - 4 inches W.C.

### **ADJUSTMENTS**

|   |  |
|---|--|
|  | <b>WARNING:</b> Adjustments and service work may be performed only by a qualified technician who is experienced in, and knowledgeable with, the operation of commercial gas cooking equipment. To assure your confidence, contact your authorized service agency for reliable service, dependable advice or other assistance, and for genuine factory parts. |
|---|--|

## **6.0 SERVICE (Continued)**

### **THERMOSTAT**

The thermostat adjustment should not be changed. Check the following before changing the thermostat.

1. With kettle cold, the pressure on the pressure gauge should read in the green vacuum zone (25 to 30 inches Hg vacuum). If not, see "Re-establishing Vacuum" section.
2. The pressure switch may be set too high or too low and causing the out of adjustment condition. A voltmeter should be used by a properly trained serviceman to determine if the pressure switch or thermostat is actually cycling the burners. If the pressure switch is found to be cycling the burners, see "Pressure Switch" section.

After verifying that the pressure switch is set and operating properly, the thermostat may be adjusted using the set screw inside the stem. At maximum setting, the thermostat should cycle off at a gauge pressure reading of 30 psi. Turn set screw clockwise to decrease pressure and counterclockwise to increase pressure.

### **PRESSURE SWITCH**

The pressure switch should not be adjusted until it is determined to be the cause of an operating pressure difficulty. See "Thermostat" section to determine if the source of difficulty is the pressure switch or thermostat.

The major difficulties caused by pressure switch mis-adjustment are:

1. Pressure relief valve opening, pressure rises above 45 psi.
2. Pressure in kettle is less than 30 psi and burner is being shut down by pressure switch (not thermostat).

The pressure switch is preset for proper operation from the factory. It is adjusted to the maximum pressure which will prevent the pressure relief valve from opening. During preheat to the maximum thermostat setting (275°F), from either a cold condition or a lower temperature setting, the temperature may overshoot the thermostat setting and be shut down by the pressure switch. This is normal, however, after the kettle has cycled several times (empty) the thermostat will begin cycling the unit.

## 6.0 **SERVICE** (Continued)

### TO ADJUST PRESSURE SWITCH:

1. To obtain access to the pressure switch, the front panel must be removed. Remove the screws on bottom of the panel. Be sure to support the panel to avoid excessive strain on the wiring.
2. To increase the pressure switch setting, turn the white ribbed knob clockwise; to decrease, turn it counterclockwise. Use the centre of the black ring as an indicator.
3. With the kettle empty and completely cold, turn kettle on and set thermostat to maximum setting (275°F).
4. The pressure in kettle (read pressure gauge on front panel) should reach a maximum of 30 psi and pressure relief valve should not open. Kettle pressure may rise 3 or 4 psi even after burners shut down.
5. Relief valve should not open when kettle pressure is 45 psi; pressure switch setting is satisfactory.
6. If the safety relief valve opens, reduce setting on pressure switch, cool kettle completely by running cold water through it and repeat steps 3 - 6.
7. If pressure in kettle is below 30 psi increase setting of pressure switch, cool kettle completely by running cold water through it and repeat steps 3 - 7.
8. Allow the kettle to cycle several times to verify the correct pressure setting.
9. Replace the front panel when adjustment is complete.

## 6.0 **SERVICE** (Continued)

### **ADDING WATER (Low water light comes on)**

It may be necessary to replenish water in the jacket when the low water indicator comes on. Do so as follows:

1. Unit should be completely cold and off.
2. Lift handle of pressure relief valve to release vacuum in kettle.
3. Remove relief valve and attach a 3/4" NPT elbow pointing upward.
4. Using pure distilled water only, pour the water into the open end of elbow (a funnel will be helpful). Water will enter kettle slowly, as air must escape through the same hole. Water should be added until water level at the sight glass is halfway between the minimum and maximum levels.
5. When sufficient water has been added, remove elbow and replace pressure relief valve. Be sure to seal threads with a pipe joint compound suitable for steam at 50 psi.
6. Vacuum must be re-established (See Re-establishing Vacuum).

#### FOR REFERENCE:

The total amount of distilled water to be added when low level pilot is illuminated:

|         |   |                    |
|---------|---|--------------------|
| KLT-20G | - | 169 fl. oz. (5 L)  |
| KLT-40G | - | 270 fl. oz. (8 L)  |
| KLT-60G | - | 372 fl. oz. (11 L) |



## **6.0 SERVICE (Continued)**

### **RE-ESTABLISHING VACUUM**

Periodically check pressure gauge when kettle is cold. Reading should be in green vacuum zone (below 0 psi). Otherwise air is present and proper heating will not occur. Use the following procedure to remove air and re-establish vacuum:

With the kettle empty, turn the thermostat knob to the highest temperature. When the pressure gauge reaches 20 psi, turn thermostat off, open the pressure relief valve until pressure gauge reads 1 psi, then sharply release it. This should remove the air and restore performance of the kettle.

Should the kettle fail to maintain a vacuum after repeated attempts to establish vacuum, further checks should be made to see if the pressure relief valve is leaking or if there are any leaks in the pressure relief valve piping, copper lines going to the pressure switch, pressure gauge or thermostat fitting.

## 7.0 TROUBLESHOOTING

| <b>PROBLEM</b>                              | <b>LOOK FOR</b>  |
|---|--|
| Motor will not run.                         | <ul style="list-style-type: none"><li>- No current. Check that power is being supplied to the unit.</li><li>- Defective thermostat or pressure switch.</li><li>- Defective motor.</li><li>- Motor overload out.</li><li>- Blown fuse.</li></ul>  |
| Motor runs, no spark.                       | <ul style="list-style-type: none"><li>- Defective transformer.</li><li>- Defective ignition module.</li><li>- Blown fuse on ignition module.</li><li>- Defective spark electrode (cracked insulator).</li><li>- Defective ignition cable.</li><li>- Defective centrifugal switch on motor.</li></ul>   |
| Motor runs, spark present, no gas ignition. | <ul style="list-style-type: none"><li>- Manual main valve off.</li><li>- Mislocated spark or ground rods. See Figure 2 for correct position</li><li>- Defective valve.</li><li>- Defective ignition module.</li><li>- Burner rate set too high. Ensure that manifold pressure is set per rating plate and that correct orifice size installed (See table page 21.</li><li>- Burner getting too much air. Reduce air shutter opening (not below 1.0).</li></ul> |
| Low water light comes on.                   | <ul style="list-style-type: none"><li>- Add water - See previous section ADJUSTMENTS.</li></ul>  |
| Relief valve opens.                         | <ul style="list-style-type: none"><li>- Pressure switch set too high.</li><li>- Pressure gauge is not accurate.</li><li>- Relief valve is faulty</li></ul>   |

Flame burns only about 6 seconds and shuts off.

- Flame rod or flame ground mislocated.
- Defective flame rod wire.
- Defective ignition module.
- Burner rate set too high. Ensure that manifold pressure is set per rating plate and that correct orifice size installed (See table page 21).
- Burner getting too much air. Reduce air shutter opening (not below 1.0).

Short flame.

- Wrong size orifice. (See table on page 21).
- Low gas pressure.
- Air shutter adjustment. (See table, shutter setting)
- Main manual valve partially closed.

Long hazy flame.

- Wrong size orifice.
- High gas pressure.
- Dirty blower wheel or intake.
- Air shutter adjustments.

Gas fails to shut off.

- Dirt on valve seat.
- Defective main valve.

**NOTE: Loose, broken or grounded wiring may cause many of the symptoms listed. Check all wiring and make sure it is intact.**

| <b>SHUTTER SETTINGS</b>       |                |                |
|-------------------------------|----------------|----------------|
| <b>Kettle Size/Gas Type</b>   | <b>Natural</b> | <b>Propane</b> |
| 20 Gallon (80,000 BTU/HR)     | 1.5            | 2.0            |
| 30/40 Gallon (100,000 BTU/HR) | 1.5            | 2.0            |
| 60 Gallon (120,000 BTU/HR)    | 2.0            | 3.0            |

Shutter setting is on the fan intake. Adjust the shutter per the table above by loosening the screw on the shutter closest to the stamped numbers and turning the shuttle disc until the screw points to the correct setting. Tighten screw when adjustment is complete. Figure 1 below shows a shutter setting of 2.0. Look at the flame through the plastic window in the rear of the burner. It should be mostly blue with slight bits of orange flame on natural gas. On propane, flame will be more orange in color. Using a portable gas analyzer, shutter settings can be adjusted to yield between 5.0-8.0 CO<sub>2</sub>. Air free CO should read below 100ppm. Once the burner is set up and operating properly, secure all wires and replace all covers.

**Figure 1 Shutter setting at 2.0**

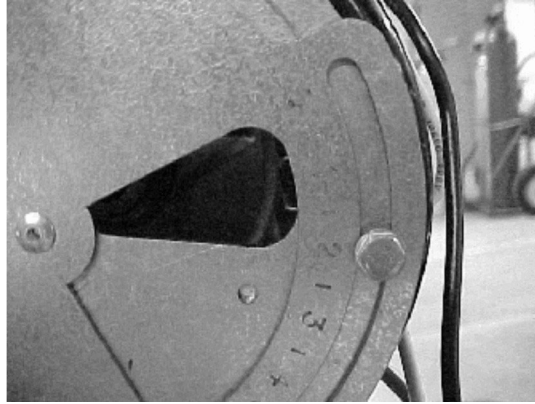

**Figure 2**

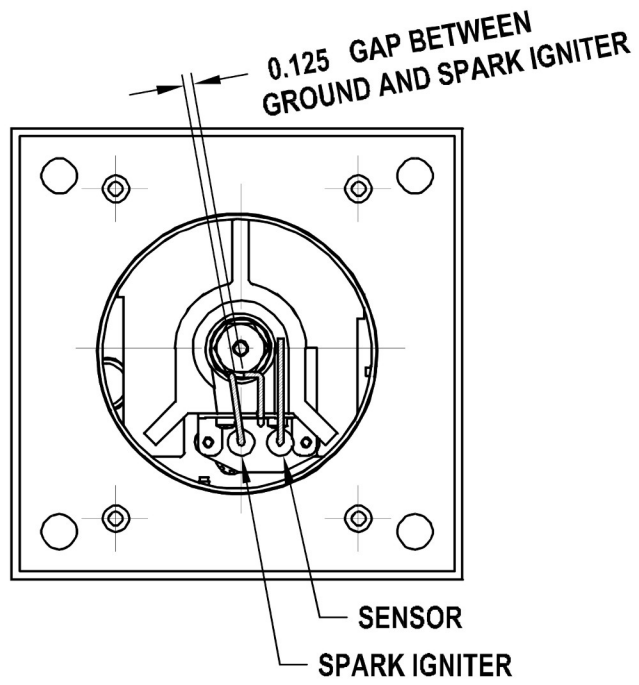

## MATERIAL SAFETY DATA SHEET

### PREPARATION INFORMATION:

Prepared for use in Canada by: E H & S Product Regulatory Management Department  
DOW CHEMICAL CANADA INC.  
P.O. Box 1012  
Sarnia, Ontario, N7T 7K7

(800) 331-6451

### 1. CHEMICAL PRODUCT AND COMPANY IDENTIFICATION

**IN CASE OF EMERGENCY:** Fort Saskatchewan, Alberta: (780) 998-8282  
Sarnia, Ontario: (519) 339-3711  
Varenes, Quebec: (450) 652-1000

**Product::** DOWFROST\* HD HEAT TRANSFER FLUID, DYED

Product Code: 04632

Effective Date: 2/20/01 Date Printed: 07/10/02 MSD: 002239

DOW CHEMICAL CANADA INC.  
P.O. Box 1012  
Sarnia, Ontario, N7T 7K7

Prepared for use in Canada by the E H & S Product Regulatory Management Department;  
Phone: (800) 331-6451.

### 2. COMPOSITION/INFORMATION ON INGREDIENTS

|                       |                  |     |     |
|-----------------------|------------------|-----|-----|
| Propylene Glycol      | CAS# 000057-55-6 |     | 94% |
| Dipotassium Phosphate | CAS# 007758-11-4 | <5% |     |
| Deionized Water       | CAS# 007732-18-5 |     | <5% |

\* or (R) indicates a trademark of The Dow Chemical Company.

## MATERIAL SAFETY DATA SHEET

Product: **DOWFROST\* HD HEAT TRANSFER FLUID, DYED**  
Product Code: 04632  
Effective Date: 02/20/01, Date Printed: 07/10/02, MSD: 002239

### 3. **HAZARDS IDENTIFICATION**

#### **EMERGENCY OVERVIEW**

|  |
|--|
| Clear yellow liquid. Odourless. Avoid temperatures above 450°F, 232°C. |
|--|

**POTENTIAL HEALTH EFFECTS** (See Section 11 for toxicological data.)

**EYE:** May cause slight transient (temporary) eye irritation. Corneal injury is unlikely. Mists may cause eye irritation.

**SKIN CONTACT:** Prolonged contact is essentially nonirritating to skin. A single prolonged exposure is not likely to result in the material being absorbed through skin in harmful amounts. Repeated exposures may cause flaking and softening of skin.

**INGESTION:** Single dose oral toxicity is considered to be extremely low. No hazards anticipated from swallowing small amounts incidental to normal handling operations.

**INHALATION:** At room temperature, vapours are minimal due to physical properties. Mists may cause irritation of upper respiratory tract (nose and throat).

**SYSTEMIC (OTHER TARGET ORGAN) EFFECTS:** Repeated excessive exposure to propylene glycol may cause central nervous system effects.

**CANCER INFORMATION:** Did not cause cancer in laboratory animals.

**TERATOLOGY (BIRTH DEFECTS):** Birth defects are unlikely. Exposures having no adverse effects on the mother should have no effect on the fetus.

**REPRODUCTIVE EFFECTS:** In animal studies, has been shown not to interfere with reproduction.

*\* or (R) indicates a trademark of The Dow Chemical Company.*

#### **MATERIAL SAFETY DATA SHEET**

Product: **DOWFROST\* HD HEAT TRANSFER FLUID, DYED**

Product Code: 04632  
Effective Date: 02/20/01, Date Printed: 07/10/02, MSD: 002239

#### 4. FIRST AID

EYES: Flush eyes with plenty of water.

SKIN: Wash off in flowing water or shower.

INGESTION: No adverse effects anticipated by this route of exposure incidental to proper industrial handling.

INHALATION: Remove to fresh air if effects occur. Consult a physician.

NOTE TO PHYSICIAN: No specific antidote. Supportive care. Treatment based on judgment of the physician in response to reactions of the patient.

#### 5. FIRE FIGHTING MEASURES

##### FLAMMABLE PROPERTIES

FLASH POINT: 214°F, 107°C (based on a similar material)

METHOD USED: PMCC

AUTOIGNITION TEMPERATURE: NOT DETERMINED

##### FLAMMABILITY LIMITS

LFL: Not determined

UFL: Not determined

*\* or (R) indicates a trademark of The Dow Chemical Company.*

## **MATERIAL SAFETY DATA SHEET**

**Product:** **DOWFROST\* HD HEAT TRANSFER FLUID, DYED**

**Product Code:** 04632

**Effective Date:** 02/20/01, **Date Printed:** 07/10/02, **MSD:** 002239

**HAZARDOUS COMBUSTION PRODUCTS:** During a fire, smoke may contain the original material in addition to unidentified toxic and/or irritating compounds. Hazardous combustion products may include and are not limited to carbon monoxide and carbon dioxide.

**OTHER FLAMMABILITY INFORMATION:** Violent steam generation or eruption may occur upon application of direct water stream to hot liquids. Flammable concentrations of vapour can accumulate at temperatures above 214°F. Liquid mist of this product can burn. Spills of these organic liquids on hot fibrous insulations may lead to lowering of the autoignition temperatures possibly resulting in spontaneous combustion. Container may rupture from gas generation in a fire situation.

**EXTINGUISHING MEDIA:** Water fog or fine spray, carbon dioxide, dry chemical, foam. Alcohol resistant foams (ATC type) are preferred if available. General purpose synthetic foams (including AFFF) or protein foams may function, but much less effectively. Do not use direct water stream. May spread fire.

**MEDIA TO BE AVOIDED:** Do not use direct water stream.

**FIRE FIGHTING INSTRUCTIONS:** Keep people away. Isolate fire area and deny unnecessary entry. Burning liquids may be moved by flushing with water to protect personnel and minimize property damage. Burning liquids may be extinguished by dilution with water. Do not use direct water stream. May spread fire. Fight fire from protected location or safe distance. Consider use of unmanned hose holder or monitor nozzles. Use water spray to cool fire exposed containers and fire affected zone until fire is out and danger of re-ignition has passed. Immediately withdraw all personnel from area in case of rising sound from venting safety device or discolouration of the container. Move container from fire area if this is possible without hazard.

**PROTECTIVE EQUIPMENT FOR FIRE FIGHTERS:** Wear positive-pressure self-contained breathing apparatus (SCBA) and protective fire fighting clothing (includes fire fighting helmet, coat, pants, boots and gloves). If protective equipment is not available or not used, fight fire from a protected location or safe distance.

*\* or (R) indicates a trademark of The Dow Chemical Company.*



## **MATERIAL SAFETY DATA SHEET**

Product: **DOWFROST\* HD HEAT TRANSFER FLUID, DYED**

Product Code: 04632

Effective Date: 02/20/01, Date Printed: 07/10/02, MSD: 002239

### **6. ACCIDENTAL RELEASE MEASURES** (See Section 15 for Regulatory Information)

PROTECT PEOPLE: Use appropriate safety equipment. For additional information, refer to Section 8, Exposure Controls/ Personal Protection.

PROTECT THE ENVIRONMENT: Avoid contamination of all waterways.

CLEAN-UP: See Section 13, Disposal Consideration.

### **7. HANDLING AND STORAGE**

SPECIAL PRECAUTIONS TO BE TAKEN IN HANDLING AND STORAGE: No special handling requirements data available.

HANDLING: See Section 8, Exposure Controls/Personal Protection.

STORAGE: See Section 10, Stability and Reactivity.

### **8. EXPOSURE CONTROLS/PERSONAL PROTECTION**

ENGINEERING CONTROLS: Provide general and/or local exhaust ventilation to control airborne levels below the exposure guidelines.

#### **PERSONAL PROTECTIVE EQUIPMENT**

EYE/FACE PROTECTION: Use safety glasses. Safety glasses should be sufficient for most operations; however, for misty operations wear chemical goggles.

SKIN PROTECTION: Use gloves impervious to this material.

RESPIRATORY PROTECTION: Atmospheric levels should be maintained below the exposure guideline. When respiratory protection is required for certain operations, use an approved air-purifying respirator. In misty atmospheres, use an approved mist respirator.

*\* or (R) indicates a trademark of The Dow Chemical Company.*

## **MATERIAL SAFETY DATA SHEET**

Product: **DOWFROST\* HD HEAT TRANSFER FLUID, DYED**

Product Code: 04632

Effective Date: 02/20/01, Date Printed: 07/10/02, MSD: 002239

EXPOSURE GUIDELINES: Propylene glycol: AIHA WEEL is 50 ppm total, 10 mg/m<sup>3</sup> aerosol only.

### **9. PHYSICAL AND CHEMICAL PROPERTIES**

|                                  |                      |
|----------------------------------|----------------------|
| APPEARANCE/PHYSICAL STATE:       | Clear yellow liquid. |
| ODOUR:                           | Odourless            |
| VAPOUR PRESSURE:                 | 0.22 mmHg @ 20°C     |
| VAPOUR DENSITY:                  | 2.6                  |
| BOILING POINT:                   | 320°F, 160°C         |
| SOLUBILITY IN WATER/MISCIBILITY: | Complete             |
| SPECIFIC GRAVITY OR DENSITY:     | 1.058 @ 25/25°C      |

### **10. STABILITY AND REACTIVITY**

CHEMICAL STABILITY: Thermally stable at typical use temperatures.

CONDITIONS TO AVOID: Avoid use temperatures above 450°F, 232°C. Product can degrade at elevated temperatures. Generation of gas during decomposition can cause pressure in closed systems.

INCOMPATIBILITY WITH OTHER MATERIALS: Avoid contact with oxidizing materials. Avoid contact with strong acids

HAZARDOUS DECOMPOSITION PRODUCTS: Hazardous decomposition products depend upon temperature, air supply and the presence of other materials.

HAZARDOUS POLYMERIZATION: Will not occur.

**11. TOXICOLOGICAL INFORMATION** (See Section 3 for Potential Health Effects. For detailed toxicological data, write or call the address or non-emergency number shown in Section 1).

SKIN: The LD<sub>50</sub> for skin absorption in rabbits is >10,000 mg/kg.

*\* or (R) indicates a trademark of The Dow Chemical Company.*

## **MATERIAL SAFETY DATA SHEET**

**Product: DOWFROST\* HD HEAT TRANSFER FLUID, DYED**

**Product Code: 04632**

**Effective Date: 02/20/01, Date Printed: 07/10/02, MSD: 002239**

SKIN: The LD50 for skin absorption in rabbits is >10,000 mg/kg.

INGESTION: The oral LD50 for rats is 20,000 - 34,000 mg/kg.

MUTAGENICITY: In vitro mutagenicity studies were negative. Animal mutagenicity studies were negative.

**12. ECOLOGICAL INFORMATION** (For detailed Ecological data, write or call the address or non-emergency number shown in Section 1.)

### ENVIRONMENTAL FATE

**MOVEMENT & PARTITIONING:** Based largely or completely on data for major component(s). Bioconcentration potential is low (BCF less than 100 or Log Pow less than 3). Potential for mobility in soil is very high (Koc between 0 and 50).

**DEGRADATION AND PERSISTENCE:** Based largely or completely on data for major component(s). Material is readily biodegradable. Passes OECD test(s) for ready biodegradability. Degradation is expected in the atmospheric environment within minutes to hours.

**ECOTOXICITY:** Based largely or completely on data for major component(s). Material is practically non-toxic to aquatic organisms on an acute basis (LC50/EC50 >100 mg/L in most sensitive species).

**13. DISPOSAL CONSIDERATIONS** (See Section 15 for Regulatory Information)

**DISPOSAL:** DO NOT DUMP INTO ANY SEWERS, ON THE GROUND OR INTO ANY BODY OF WATER. All disposal methods must be in compliance with all Federal, State/Provincial and local laws and regulations. Regulations may vary in different locations. Waste characterizations and compliance with applicable laws are the responsibility solely of the waste generator. THE DOW CHEMICAL COMPANY HAS NO CONTROL OVER THE MANAGEMENT PRACTICES OR MANUFACTURING PROCESSES OF PARTIES HANDLING OR USING THIS MATERIAL. THE INFORMATION PRESENTED HERE PERTAINS ONLY TO THE PRODUCT AS SHIPPED IN ITS INTENDED CONDITION AS DESCRIBED IN MSDS SECTION 2 (Composition/Information On Ingredients).

*\* or (R) indicates a trademark of The Dow Chemical Company.*

## **MATERIAL SAFETY DATA SHEET**

**Product: DOWFROST\* HD HEAT TRANSFER FLUID, DYED**

**Product Code: 04632**

**Effective Date: 02/20/01, Date Printed: 07/10/02, MSD: 002239**

FOR UNUSED & UNCONTAMINATED PRODUCT, the preferred options include sending to a licensed, permitted: recycler, reclaimer, incinerator or other thermal destruction device.

As a service to its customers, Dow can provide names of information resources to help identify waste management companies and other facilities which recycle, reprocess or manage chemicals or plastics, and that manage used drums. Telephone Dow's Customer Information Center at 800-258-2436 or 989-832-1556 for further details.

### **14. TRANSPORT INFORMATION**

**DEPARTMENT OF TRANSPORTATION (D.O.T.):** For D.O.T. regulatory information, if required, consult transportation regulations, product shipping papers, or contact your Dow representative.

**CANADIAN TDG INFORMATION:** For TDG regulatory information, if required, consult transportation regulations, product shipping papers, or your Dow representative.

### **15. REGULATORY INFORMATION** (Not meant to be all-inclusive – selected regulations represented).

**NOTICE:** The information herein is presented in good faith and believed to be accurate as of the effective date shown above. However, no warranty, express or implied is given. Regulatory requirements are subject to change and may differ from one location to another; it is the buyer's responsibility to ensure that its activities comply with federal, state or provincial, and local laws. The following specific information is made for the purpose of complying with numerous federal, state or provincial, and local laws and regulations. See other sections for health and safety information.

*\* or (R) indicates a trademark of The Dow Chemical Company.*

## MATERIAL SAFETY DATA SHEET

Product: DOWFROST\* HD HEAT TRANSFER FLUID, DYED

Product Code: 04632

Effective Date: 02/20/01, Date Printed: 07/10/02, MSD: 002239

### U.S. REGULATIONS

SARA 313 INFORMATION: To the best of our knowledge, this product contains no chemical subject to SARA Title III Section 313 supplier notification requirements.

SARA HAZARD CATEGORY: This product has been reviewed according to the EPA "Hazard Categories" promulgated under Sections 311 and 312 of the Superfund Amendment and Reauthorization Act of 1986 (SARA Title III) and is considered, under applicable definitions, to meet the following categories:

Not to have met any hazard category.

TOXIC SUBSTANCES CONTROL ACT (TSCA):

All ingredients are on the TSCA inventory or are not required to be listed on the TSCA inventory.

STATE RIGHT-TO-KNOW: The following product components are cited on certain state lists as mentioned. Non-listed components may be shown in the composition section of the MSDS.

| <u>CHEMICAL NAME</u> | <u>CAS NUMBER</u> | <u>LIST</u> |
|----------------------|-------------------|-------------|
|----------------------|-------------------|-------------|

|                  |             |     |
|------------------|-------------|-----|
| 1, 2-Propanediol | 000057-55-6 | PA1 |
|------------------|-------------|-----|

PA1= Pennsylvania Hazardous Substance (present at greater than or equal to 1.0%).

OSHA HAZARD COMMUNICATION STANDARD:

This product is not a "Hazardous Chemical" as defined by the OSHA Hazard Communication Standard, 29 CFR 1910.1200.

*\* or (R) indicates a trademark of The Dow Chemical Company.*

## MATERIAL SAFETY DATA SHEET

Product: **DOWFROST\* HD HEAT TRANSFER FLUID, DYED**

Product Code: 04632

Effective Date: 02/20/01, Date Printed: 07/10/02, MSD: 002239

### **CANADIAN REGULATIONS**

WHMIS INFORMATION: The Canadian Workplace Hazardous Materials Information System (WHMIS) Classification for this product is:

This product is not a "Controlled Product" under WHMIS.

CANADIAN ENVIRONMENTAL PROTECTION ACT (CEPA)

This product contains one or more substances which are not listed on the Canadian Domestic Substances List (DSL). Contact your Dow representative for more information.

### **16. OTHER INFORMATION**

MSDS STATUS: Revised to 16 section format.

*\* or (R) indicates a trademark of The Dow Chemical Company.*

*The information herein is given in good faith, but no warranty, express or implied, is made. Consult The Dow Chemical Company for further information.*