



N8000-R

Drop-In Curved Ice Cooled Cold Pan

Project _____

Item _____

Quantity _____

CSI Section 11400

Approved _____

Date _____

N8000-R:

Drop-In Curved Ice Cooled Cold Pan

Models

- N8044-R Ice cooled cold well, fits 2 standard 12" x 20" pans
- N8059-R Ice cooled cold well, fits 3 standard 12" x 20" pans
- N8076-R Ice cooled cold well, fits 4 standard 12" x 20" pans
- N8094-R Ice cooled cold well, fits 5 standard 12" x 20" pans

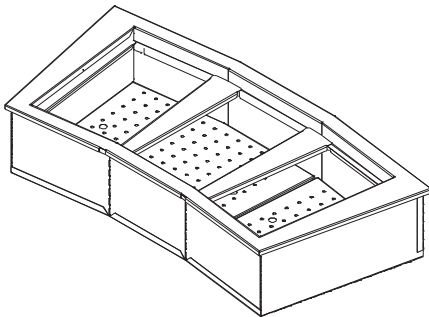

N8059-R

Standard Features

- NSF certified
- Stainless steel holding clips secure pans
- Push-in perimeter gasket
- 1" drain standard
- Environmentally friendly, Kyoto Protocol Compliant, Non ODP (Ozone Depletion Potential), Non GWP (Global Warming Potential) polyurethane foam insulation
- Removable perforated, false bottom
- One year parts and 90 day labor standard warranty

Options & Accessories

- Custom pan template
- Adaptor bars
- Pans
- Flexishield® food shields, single or dual service



N8044-R

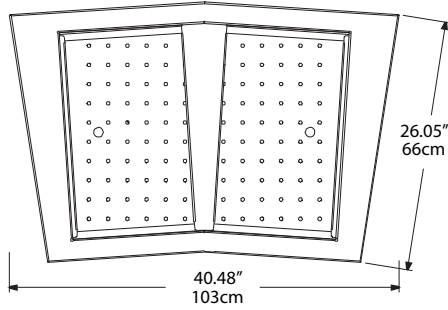

N8044-R Plan View

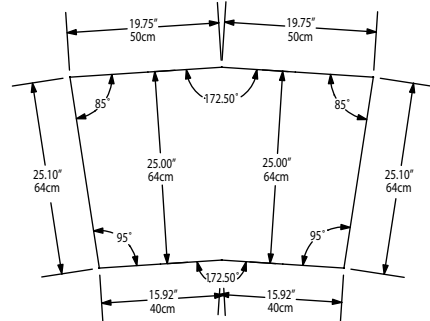

N8044-R Cutout Dimensions

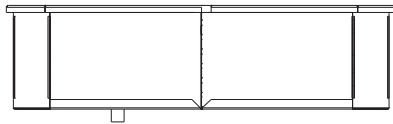

N8044-R Elevation View

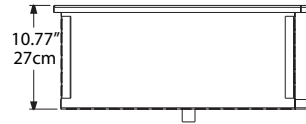

N8044-R Side View

N8059-R

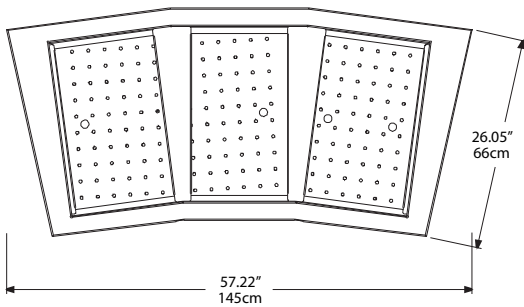

N8059-R Plan View

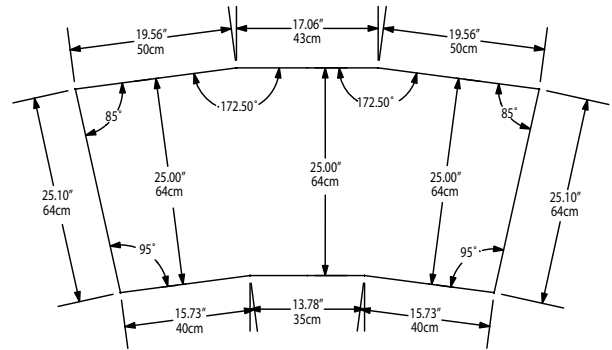

N8059-R Cutout Dimensions

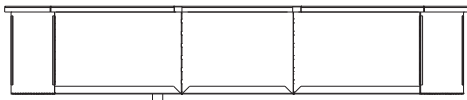

N8059-R Elevation View



N8059-R Side View

N8076-R

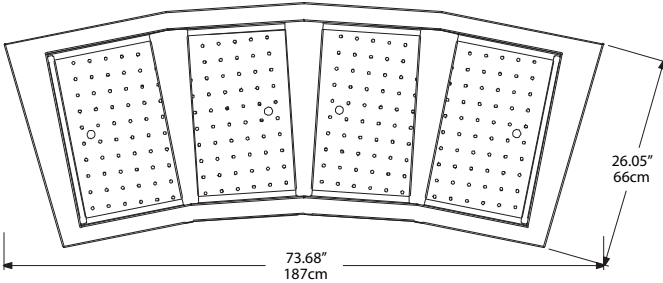

N8076-R Plan View

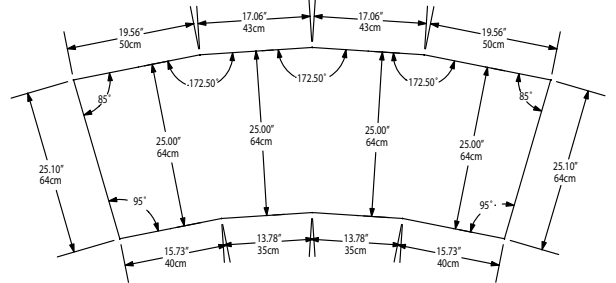

N8076-R Cutout Dimensions

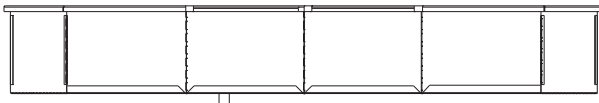

N8076-R Elevation View

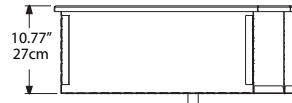

N8076-R Side View

N8094-R

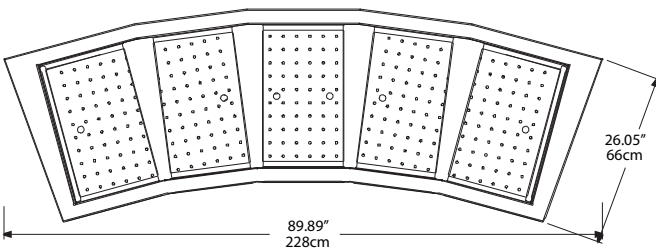

N8094-R Plan View

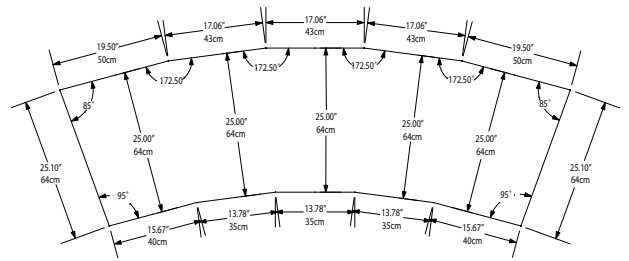

N8094-R Cutout Dimensions



N8094-R Elevation View

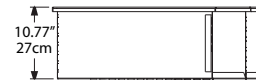

N8094-R Side View



N8000-R

Drop-In Curved Ice Cooled Cold Pan

Specifications

Top is one piece 18-gauge stainless steel. Interior liner is 22-gauge stainless steel and is creased to 1.00" (3cm) diameter drain. Unit has a sectional, removable perforated stainless steel false bottom. Stainless steel holding clips and adapter bars are provided to allow placement of 12" x 20" (30cm x 51cm) pans. Unit is supplied with 1" (3cm) plastic drain to be installed by customer. Exterior housing is 24-gauge galvanized steel. Unit is insulated with high density closed cell environmentally friendly, Kyoto Protocol Compliant, Non ODP (Ozone Depletion Potential), Non GWP (Global Warming Potential) polyurethane.

Specifications

Model	# Of 12" x 20" Pans Held	Shipping Weight
N8044-R	2	100lbs/45kg
N8059-R	3	118lbs/53kg
N8076-R	4	145lbs/65kg
N8094-R	5	164lbs/74kg

Delfield reserves the right to make changes to the design or specifications without prior notice.

