



N8700-R

Drop-In Curved Individually Controlled Heated Electric Food Wells

Project _____

Item _____

Quantity _____

CSI Section 11400

Approved _____

Date _____

N8700-R:

Drop-In Curved Individually Controlled Heated Electric Food Wells

Models

- N8744-R Heated food wells, fits two standard 12" x 20" pans
- N8759-R Heated food wells, fits three standard 12"x 20" pans
- N8776-R Heated food wells, fits four standard 12"x 20" pans
- N8794-R Heated food wells, fits five standard 12"x 20" pans

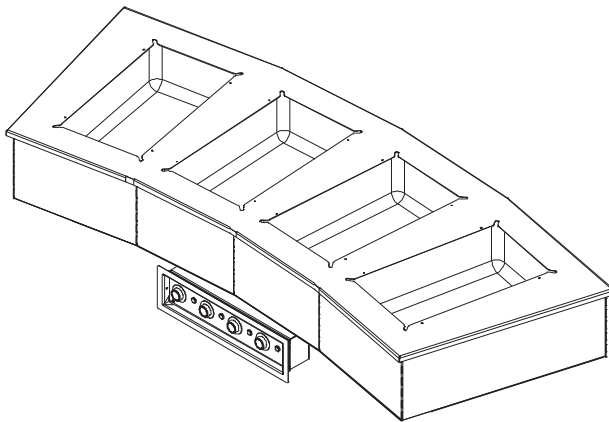

N8776-R

Standard Features

- Top is constructed of 18-gauge stainless steel
- Flush mounted die stamped drawn 12" x 20" individual 20-gauge wells
- Wells depressed slightly into the top to hold in condensation
- Standard 1/2" stainless steel drain(s)
- Non-marring press fit top gasket
- Must be hard wired in the field
- Wet and dry operation
- 11.87" x 19.87" single hot food wells are manifolded together standard to one main gate valve
- Unit shall be insulated on all sides with 1" of fiberglass and bottom to have 2" of fiberfrax blanket insulation
- Individual infinite temperature controls standard

wired to one main control panel with 4' of conduit and wire. Field install control panel at location

- Galvanized exterior body
- One year parts and 90 day labor standard warranty

Options & Accessories

- Adapter plates and bars
 - Single- or double-service flip-up sneezeguards
 - Flexishield® food shields, single or dual service
 - Omit drains and manifold
 - 220 volt, 50 cycle electrical system*
- * Inclusion of this option will alter electrical specifications of the unit



N8744-R

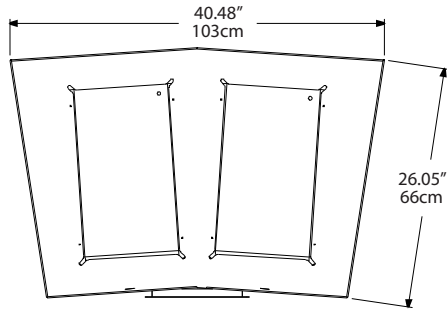

N8744-R Plan View

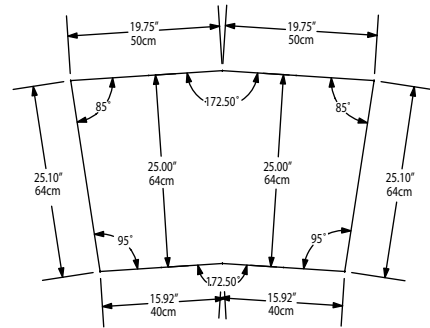

N8744-R Cutout Dimensions

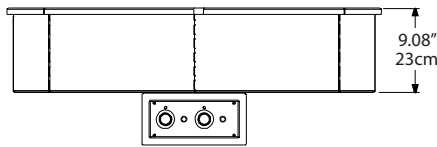

N8744-R Elevation View

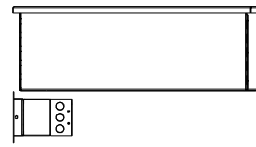

N8744-R Side View

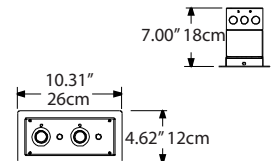

N8744-R Remote Control Cutout Dimensions

N8759-R

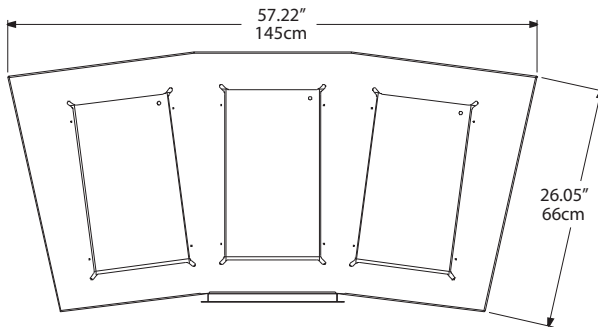

N8759-R Plan View

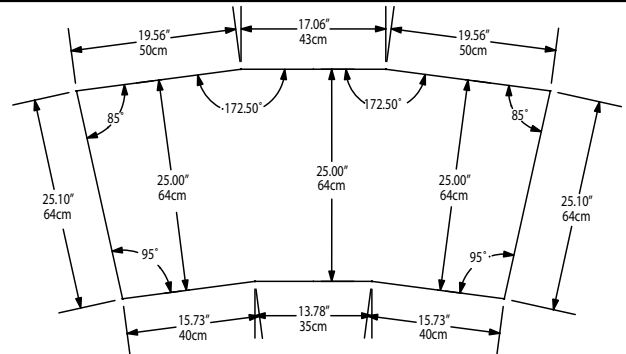

N8759-R Cutout Dimensions

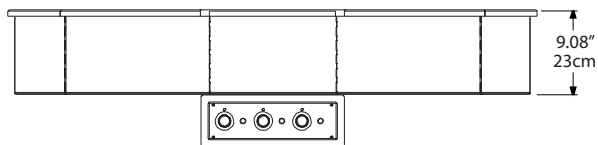

N8759-R Elevation View

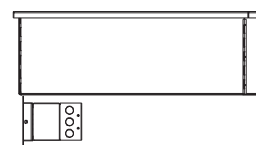

N8759-R Side View

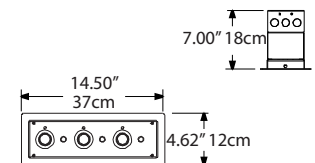

N8759-R Remote Control Cutout Dimensions

N8776-R

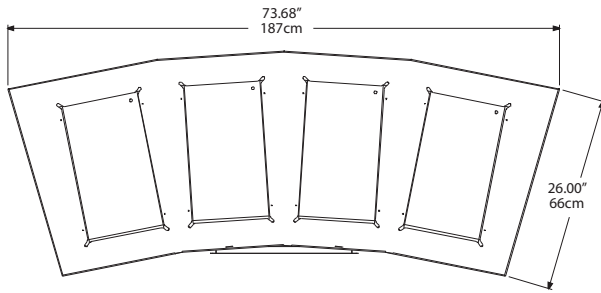

N8776-R Plan View

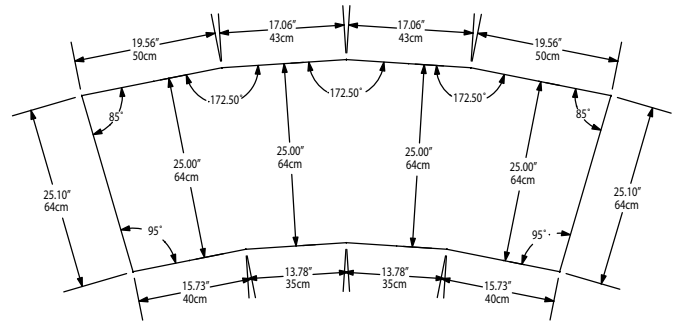

N8776-R Cutout Dimensions

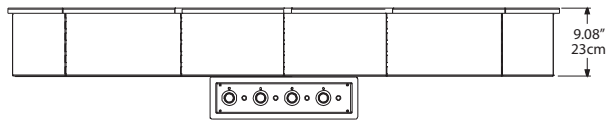

N8776-R Elevation View

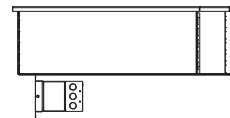

N8776-R Side View

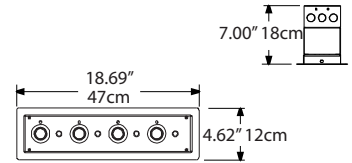

N8776-R Remote Control Cutout Dimensions

N8794-R

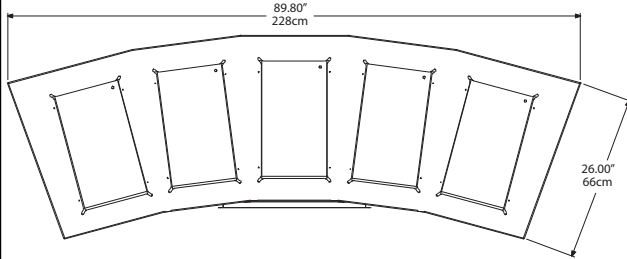

N8794-R Plan View

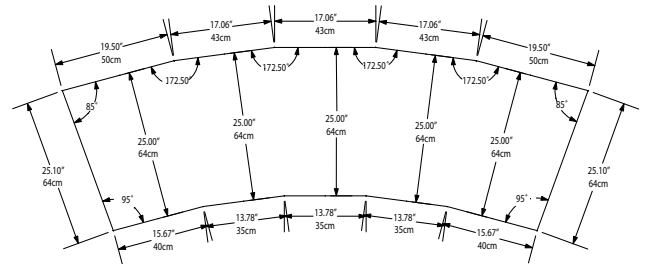

N8794-R Cutout Dimensions

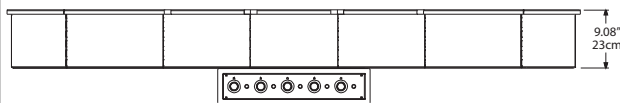

N8794-R Elevation View

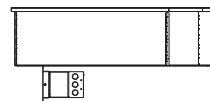

N8794-R Side View

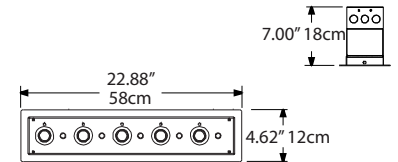

N8794-R Remote Control Cutout Dimensions



N8700-R

Drop-In Curved Individually Controlled Heated Electric Food Wells

Specifications

Top shall be one-piece 18-gauge stainless steel, with die-stamped 19.87" x 11.87" (50.5cm x 30.2cm) openings with depressed edges. Formed well below each opening shall be 6.25" (15.9cm) deep. Each well shall have an individual temperature control and 1000 watt heating element attached to bottom of well. Each well shall be equipped with a .5" female N.P.T. drain located in right rear corner. All drains manifold to a .5" gate valve at the left. Exterior housing shall be 20-gauge galvanized steel. Unit shall be insulated on sides and between wells with 1.00" (2.5cm) fiberglass; bottom shall have 2.00" (5.1cm) blanket insulation.

Unit shall have all individual controls wired to a control panel for mounting in counter or at a remote location; 4' (1.2 m) length of wiring and conduit are provided. Unit shall have a three-wire electrical junction box to allow hard-wiring at installation.

Specifications

Model	# Of 12"x 20" Pans Held	Volts/Hertz/Phase	Amps	Watts	Ship Weight
N8744-R	2	120/60/1	16.6	2000	99lbs/45kg
N8759-R	3	208-230/60/1	15.0/16.0	3000/4000	134lbs/61kg
N8776-R	4	208-230/60/1	20.0/22.0	4000/4800	166lbs/75kg
N8794-R	5	208-230/60/1	24.0/27.0	5000/6000	186lbs/84kg

Delfield reserves the right to make changes to the design or specifications without prior notice.

