

Performance Pro Series  
Gas Fryers Models 35 & 45  
Installation and Operation Manual



Frymaster, a member of the Commercial Food Equipment Service Association, recommends using CFESA Certified Technicians.

[www.frymaster.com](http://www.frymaster.com)

24-Hour Service Hotline 1-800-551-8633

OCTOBER 2011

\* 8196042A \*

E-mail:

[service@frymaster.com](mailto:service@frymaster.com)

**NOTICE**

IF, DURING THE WARRANTY PERIOD, THE CUSTOMER USES A PART FOR THIS MANITOWOC FOOD SERVICE EQUIPMENT OTHER THAN AN **UNMODIFIED** NEW OR RECYCLED PART PURCHASED DIRECTLY FROM FRYMASTER/DEAN, OR ANY OF ITS AUTHORIZED SERVICERS, AND/OR THE PART BEING USED IS MODIFIED FROM ITS ORIGINAL CONFIGURATION, THIS WARRANTY WILL BE VOID. FURTHER, FRYMASTER/DEAN AND ITS AFFILIATES WILL NOT BE LIABLE FOR ANY CLAIMS, DAMAGES OR EXPENSES INCURRED BY THE CUSTOMER WHICH ARISE DIRECTLY OR INDIRECTLY, IN WHOLE OR IN PART, DUE TO THE INSTALLATION OF ANY MODIFIED PART AND/OR PART RECEIVED FROM AN UNAUTHORIZED SERVICER.

**NOTICE**

This appliance is intended for professional use only and is to be operated by qualified personnel only. A Frymaster/DEAN Factory Authorized Servicer (FAS) or other qualified professional should perform installation, maintenance, and repairs. Installation, maintenance, or repairs by unqualified personnel may void the manufacturer's warranty. See Chapter 1 of this manual for definitions of qualified personnel.

**NOTICE**

This equipment must be installed in accordance with the appropriate national and local codes of the country and/or region in which the appliance is installed. See NATIONAL CODE REQUIREMENTS in Chapter 2 of this manual for specifics.

**NOTICE TO U.S. CUSTOMERS**

This equipment is to be installed in compliance with the basic plumbing code of the Building Officials and Code Administrators International, Inc. (BOCA) and the Food Service Sanitation Manual of the U.S. Food and Drug Administration.

**NOTICE**

Drawings and photos used in this manual are intended to illustrate operational, cleaning and technical procedures and may not conform to onsite management operational procedures.

**NOTICE TO OWNERS OF UNITS EQUIPPED WITH COMPUTERS**

**U.S.**

This device complies with Part 15 of the FCC rules. Operation is subject to the following two conditions: 1) This device may not cause harmful interference, and 2) This device must accept any interference received, including interference that may cause undesired operation. While this device is a verified Class A device, it has been shown to meet the Class B limits.

**CANADA**

This digital apparatus does not exceed the Class A or B limits for radio noise emissions as set out by the ICES-003 standard of the Canadian Department of Communications.

Cet appareil numérique n'émet pas de bruits radioélectriques dépassant les limites de classe A et B prescrites dans la norme NMB-003 édictée par le Ministre des Communications du Canada.

** DANGER**

Improper installation, adjustment, maintenance or service, and unauthorized alterations or modifications can cause property damage, injury, or death. Read the installation, operating, and service instructions thoroughly before installing or servicing this equipment. Only qualified service personnel may convert this appliance to use a gas other than that for which it was originally configured.

**⚠ DANGER**

No structural material on the fryer should be altered or removed to accommodate placement of the fryer under a hood. Questions? Call the Frymaster/Dean Service Hotline at 1-800-551-8633.

**⚠ DANGER**

Adequate means must be provided to limit the movement of this appliance without depending upon the gas line connection. Single fryers equipped with legs must be stabilized by installing anchor straps. All fryers equipped with casters must be stabilized by installing restraining chains. If a flexible gas line is used, an additional restraining cable must be connected at all times when the fryer is in use.

**⚠ DANGER**

The front ledge of the fryer is not a step! Do not stand on the fryer. Serious injury can result from slips or contact with the hot oil.

**⚠ DANGER**

Do not store or use gasoline or other flammable liquids or vapors in the vicinity of this or any other appliance.

**⚠ DANGER**

Instructions to be followed in the event the operator smells gas or otherwise detects a gas leak must be posted in a prominent location. This information can be obtained from the local gas company or gas supplier.

**⚠ DANGER**

This product contains chemicals known to the state of California to cause cancer and/or birth defects or other reproductive harm.

Operation, installation, and servicing of this product could expose you to airborne particles of glasswool or ceramic fibers, crystalline silica, and/or carbon monoxide. Inhalation of airborne particles of glasswool or ceramic fibers is known to the State of California to cause cancer. Inhalation of carbon monoxide is known to the State of California to cause birth defects or other reproductive harm.

**⚠ DANGER**

The crumb tray in fryers equipped with a filter system must be emptied into a fireproof container at the end of frying operations each day. Some food particles can spontaneously combust if left soaking in certain shortening material.

**⚠ WARNING**

Do not bang fry baskets or other utensils on the fryer's joiner strip. The strip is present to seal the joint between the fry vessels. Banging fry baskets on the strip to dislodge shortening will distort the strip, adversely affecting its fit. It is designed for a tight fit and should only be removed for cleaning.



**Performance Pro Series Gas Fryers Models 35 & 45  
Installation and Operation Manual**

**TABLE OF CONTENTS**

	<b>Page</b>
<b>Chapter 1: Introduction</b> .....	<b>1-1</b>
<b>Chapter 2: Installation Instructions</b> .....	<b>2-1</b>
<b>Chapter 3: Operating Instructions</b> .....	<b>3-1</b>
<b>Chapter 4: Filtration Instructions</b> .....	<b>4-1</b>
<b>Chapter 5: Preventive Maintenance</b> .....	<b>5-1</b>
<b>Chapter 6: Operator Troubleshooting</b> .....	<b>6-1</b>

# PERFORMANCE PRO SERIES GAS FRYERS MODELS 35 & 45

## CHAPTER 1: GENERAL INFORMATION

---

### 1.1 Applicability and Validity

The Pro Series Gas Fryer has been approved by the European Union for sale and installation in all EU countries.

This manual is applicable to and valid for all Performance Pro Series Atmospheric Gas Fryers sold in English-speaking countries, including those in the European Union. Where conflicts exist between instructions and information in this manual and local or national codes of the country in which the equipment is installed, installation and operation shall comply with those codes.

This appliance is only for professional use and shall be used by qualified personnel only, as defined in Section 1.7.

### 1.2 Parts Ordering and Service Information

In order to assist you quickly, the Frymaster Factory Authorized Servicer (FAS) or Service Department representative requires certain information about your equipment. Most of this information is printed on a data plate affixed to the inside of the fryer door. Part numbers are found in the Service, and Parts Manual. Parts orders may be placed directly with your local FAS or distributor. A list of Frymaster Factory Authorized Servicers (FAS's) is located on the Frymaster website at [www.frymaster.com](http://www.frymaster.com). If you do not have access to this list, contact the Frymaster Service Department at 1-800-551-8633 or 1-318-865-1711.

When ordering parts, the following information is required:

Model Number: \_\_\_\_\_  
Serial Number: \_\_\_\_\_  
Type of Gas or Voltage: \_\_\_\_\_  
Item Part Number: \_\_\_\_\_  
Quantity Needed: \_\_\_\_\_

Service information may be obtained by contacting your local FAS/Distributor. Service may also be obtained by calling the Frymaster Service Department at 1-800-551-8633 or 1-318-865-1711. When requesting service, please have the following information ready:

Model Number: \_\_\_\_\_  
Serial Number: \_\_\_\_\_  
Type of Gas: \_\_\_\_\_

In addition to the model number, serial number, and type of gas, please be prepared to describe the nature of the problem and have ready any other information that you think may be helpful in solving your problem.

**RETAIN AND STORE THIS MANUAL IN A SAFE PLACE FOR FUTURE USE.**

### 1.3 Safety Information

Before attempting to operate your unit, read the instructions in this manual thoroughly. Throughout this manual, you will find notations enclosed in double-bordered boxes similar to the ones that follow.

 **CAUTION**

**CAUTION** boxes contain information about actions or conditions that *may cause or result in a malfunction of your system.*

 **WARNING**

**WARNING** boxes contain information about actions or conditions that *may cause or result in damage to your system*, and which may cause your system to malfunction.

 **DANGER**

**DANGER** boxes contain information about actions or conditions that *may cause or result in injury to personnel*, and which may cause damage to your system and/or cause your system to malfunction.

Your fryer is equipped with automatic safety features:

1. High temperature detection shuts off gas to the burner assembly should the controlling thermostat fail.
2. A safety switch built into the drain valve prevents burner ignition with the drain valve even partially open.

### 1.4 European Community (CE) Specific Information

The European Community (CE) has established certain specific standards regarding equipment of this type. Whenever a conflict exists between CE and non-CE standards, the information or instructions concerned are identified by means of shadowed boxes similar to the one below.

<b>Non-CE Standard for Incoming Gas Pressures</b>		
<b>Type</b>	<b>Minimum</b>	<b>Maximum</b>
Natural	6" W.C.	14" W.C.
	1.49 kPa	3.49 kPa
	14.68 mbar	34.72 mbar
LP	11" W.C.	14" W.C.
	2.74 kPa	3.49 kPa
	27.28 mbar	34.84 mbar

## 1.5 Equipment Description

All Performance Pro Series fryers are of an open-frypot design with no tubes and have a hand-sized opening into the deep cold zone, which makes cleaning the frypot quick and easy.

Frypots are constructed of welded, heavy-gauge cold-rolled steel or stainless steel. Heating is supplied by a burner assembly having multiple gas jets that are focused on ceramic targets located around the lower side of the frypot. The burner assembly can be configured for natural gas, propane gas, or manufactured gas. The frypot is drained with a manual ball valve.

Performance Pro Series fryers are equipped with a thermostat probe for precise temperature control. The probe is located on the centerline of the frypot for rapid response to changes in loads and to provide the most accurate temperature measurement. Fryers in the 45-model family may have dual-vat frypots (frypots divided in half). Each half of the dual-vat frypots has its own temperature probe.

Controls on Performance Pro Series fryers vary depending on the model and configuration purchased. Control options can include thermostat controls, solid-state (analog) controllers, digital controllers, or Computer Magic 3.5 computers. Not all models are available with all controller options. Each controller is covered in detail in the separate Frymaster Fryer Controllers User's Manual provided with your equipment.

Performance Pro Series fryers may be equipped with an optional melt cycle feature, which pulses the burner on and off at a controlled rate. The melt cycle feature is designed to prevent scorching and uneven heating of the frypot when using solid shortening.

Fryers in this series may be configured with pilot ignition or electronic ignition. Fryers configured with electronic ignition and/or electric controls and all fryers equipped with built-in filtration require an external source of AC electrical power. Units can be configured for voltages ranging from 100 VAC to 240 VAC.

Fryers equipped with built-in filtration systems are shipped completely assembled. Fryers without built-in filtration require installation of legs or optional casters at point of use. All fryers are shipped with a package of standard accessories. Each fryer is adjusted, tested, and inspected at the factory before crating for shipment.

### Model Designations

The primary difference between the fryer models in this series is the size of the frypot.

- **35** models have a frypot capacity of 30-40 pounds of cooking oil or shortening and are designed for low-volume all-purpose frying.
- **45** models have a frypot capacity of 40-50 pounds of cooking oil or shortening and are designed for high-volume frying of non-breaded products.

Fryers in the Performance Pro series may be equipped with basket lifts (**BL** in the designation) and a built-in filtration system. Fryers having a **PMJ** designation have no built-in filtration. Garland Model GF16FR is represented by Model PMJ35. Fryers having a **FPP** designation have a built-in filtration system under the two leftmost **fryers**. Those having a **FMP** designation have a built-in filtration system under the two leftmost **stations** and a holding station. The holding station can be at any position in the battery.

<b>35 Model Family</b>		
<b>Model</b>	<b>Built-In Filtration</b>	<b>Controls</b> <b>(Note: Millivolt controls require no external power.)</b>
PMJ*35†	No	Millivolt. Thermostat knob inside door.
PMJ*35G†	No	Millivolt. Thermostat knob on control panel.
PMJ*35GBL†	No	Millivolt. Thermostat knob on control panel with push-button basket lift control.
PMJ*35E	No	Electric. Thermostat knob on control panel with ON/OFF switch or Solid State Controller or Digital Controller.
PMJ*35EC	No	Electric. CM III Computer.
PMJ*35EBL	No	Electric. Thermostat knob on control panel with push-button basket lift control and ON/OFF switch or Basket Lift Timer.
PMJ*35EBLC	No	Electric. CM III Computer.
PMJ*35EBLM	No	Electric. Thermostat knob on control panel with push-button basket lift control plus ON/OFF and melt cycle switches.
PMJ*35EM	No	Electric. Thermostat knob on control panel with ON/OFF and melt cycle switches.
FMP*35 or FPP*35	Yes	Millivolt. Thermostat knob on control panel. (Requires external power supply for filter.)
FMP*35E or FPP*35E	Yes	Electric. Thermostat knob on control panel with ON/OFF switch or Solid State Controller or Digital Controller.
FMP*35EC or FPP*35EC	Yes	Electric. CM III Computer.
FMP*35EBL or FPP*35EBL	Yes	Electric. Thermostat knob on control panel with push-button basket lift control and ON/OFF switch or Basket Lift Timer.
FMP*35EBLC or FPP*35EBLC	Yes	Electric. CM III Computer.
FMP*35EBLM or FPP*35EBLM	Yes	Electric. Thermostat knob on control panel with push-button basket lift control plus ON/OFF and melt cycle switches.
FMP*35EM or FPP*35EM	Yes	Electric. Thermostat knob on control panel with ON/OFF and melt cycle switches.

\* Insert the number of fryers in the battery (e.g., a PMJ135 has one fryer, a PMJ235 or an FPP235 has two fryers; an FMP135 has one fryer and one holding station, an FMP235 has two fryers and one holding station. There is no FPP135).

† Available with pilot ignition only.

<b>45 Model Family</b>		
<b>Model</b>	<b>Built-In Filtration</b>	<b>Controls</b> <b>(Note: Millivolt controls require no external power.)</b>
PMJ*45†	No	Millivolt. Thermostat knob inside door.
PMJ*45G†	No	Millivolt. Thermostat knob on control panel.
PMJ*45GBL†	No	Millivolt. Thermostat knob on control panel with push-button basket lift control.
PMJ*45E	No	Electric. Thermostat knob on control panel with ON/OFF switch or Solid State Controller or Digital Controller.

*Table continued on following page.*



<b>45 Model Family (continued from previous page)</b>		
<b>Model</b>	<b>Built-In Filtration</b>	<b>Controls</b> (Note: Millivolt controls require no external power.)
<b>PMJ*45EC</b>	No	Electric. CM III Computer.
<b>PMJ*45EBL</b>	No	Electric. Thermostat knob on control panel with push-button basket lift control and ON/OFF switch or Basket Lift Timer.
<b>PMJ*45EBLC</b>	No	Electric. CM III Computer.
<b>PMJ*45EBLM</b>	No	Electric. Thermostat knob on control panel with push-button basket lift control plus ON/OFF and melt cycle switches.
<b>PMJ*45EM</b>	No	Electric. Thermostat knob on control panel with ON/OFF and melt cycle switches.
<b>FMP*45 or FPP*45</b>	Yes	Millivolt. Thermostat knob on control panel. (Requires external power supply for filter.)
<b>FMP*45E or FPP*45E</b>	Yes	Electric. Thermostat knob on control panel with ON/OFF switch or Solid State Controller or Digital Controller.
<b>FMP*45EC or FPP*45EC</b>	Yes	Electric. CM III Computer.
<b>FMP*45EBL or FPP*45EBL</b>	Yes	Electric. Thermostat knob on control panel with push-button basket lift control and ON/OFF switch or Basket Lift Timer.
<b>FMP*45EBLC or FPP*45EBLC</b>	Yes	Electric. CM III Computer.
<b>FMP*45EBLM or FPP*45EBLM</b>	Yes	Electric. Thermostat knob on control panel with push-button basket lift control plus ON/OFF and melt cycle switches.
<b>FMP*45EM or FPP*45EM</b>	Yes	Electric. Thermostat knob on control panel with ON/OFF and melt cycle switches.

\* Insert the number of fryers in the battery (e.g., a PMJ145 has one fryer, a PMJ245 or an FPP245 has two fryers; an FMP145 has one fryer and one holding station, an FMP245 has two fryers and one holding station. There is no FPP145).

† Available with pilot ignition only.

## 1.6 Installation, Operating, and Service Personnel

Operating information for Frymaster equipment has been prepared for use by qualified and/or authorized personnel only, as defined in Section 1.7. **All installation and service on Frymaster equipment must be performed by qualified, certified, licensed, and/or authorized installation or service personnel, as defined in Section 1.7.**

## 1.7 Definitions

### QUALIFIED AND/OR AUTHORIZED OPERATING PERSONNEL

Qualified/authorized operating personnel are those who have carefully read the information in this manual and have familiarized themselves with the equipment functions, or who have had previous experience with the operation of the equipment covered in this manual.

### QUALIFIED INSTALLATION PERSONNEL

Qualified installation personnel are individuals, firms, corporations, and/or companies which, either in person or through a representative, are engaged in and are responsible for the installation of gas-fired appliances. Qualified personnel must be experienced in such work, be familiar with all gas

precautions involved, and have complied with all requirements of applicable national and local codes.

### **QUALIFIED SERVICE PERSONNEL**

Qualified service personnel are those who are familiar with Frymaster equipment and who have been authorized by Frymaster, L.L.C. to perform service on the equipment. All authorized service personnel are required to be equipped with a complete set of service and parts manuals, and to stock a minimum amount of parts for Frymaster equipment. A list of Frymaster Factory Authorized Servicers (FAS's) is located on the Frymaster website at [www.frymaster.com](http://www.frymaster.com). *Failure to use qualified service personnel will void the Frymaster warranty on your equipment.*

### **1.8 Shipping Damage Claim Procedure**

Your Frymaster equipment was carefully inspected and packed before leaving the factory. The transportation company assumes full responsibility for safe delivery upon its acceptance of the equipment for transport.

#### **What to do if your equipment arrives damaged:**

1. **File a claim for damages immediately**, regardless of the extent of damages.
2. **Inspect for and record all visible loss or damage**, and ensure that this information is noted on the freight bill or express receipt and is signed by the person making the delivery.
3. **Concealed loss or damage** that was unnoticed until the equipment was unpacked should be recorded and reported to the freight company or carrier **immediately** upon discovery. A concealed damage claim must be submitted within 15 days of the date of delivery. Ensure that the shipping container is retained for inspection.

***Frymaster* DOES NOT ASSUME RESPONSIBILITY FOR DAMAGE OR LOSS INCURRED IN TRANSIT.**

# PERFORMANCE PRO SERIES GAS FRYERS MODELS 35 & 45

## CHAPTER 2: INSTALLATION INSTRUCTIONS

---

### 2.1 General Installation Requirements

Qualified, licensed, and/or authorized installation or service personnel, as defined in Section 1.7 of this manual, should perform all installation and service on Frymaster equipment.

Conversion of this appliance from one type of gas to another should only be performed by qualified, licensed, and/or authorized installation or service personnel as defined in Section 1.7 of this manual.

Failure to use qualified, licensed, and/or authorized installation or service personnel (as defined in Section 1.7 of this manual) to install, convert to another gas type or otherwise service this equipment will void the Frymaster warranty and may result in damage to the equipment or injury to personnel.

Where conflicts exist between instructions and information in this manual and local or national codes or regulations, installation and operation shall comply with the codes or regulations in force in the country in which the equipment is installed.

 **DANGER**

**Building codes prohibit a fryer with its open tank of hot oil/shortening being installed beside an open flame of any type, including those of broilers and ranges.**

Upon arrival, inspect the fryer carefully for visible or concealed damage. (See **Shipping Damage Claim Procedure** in Chapter 1.)

 **DANGER**

**Frymaster appliances equipped with legs are for stationary installations. Appliances fitted with legs must be lifted during movement to avoid damage to the appliance and bodily injury. For movable installations, optional equipment casters must be used. Questions? Call 1-800-551-8633.**

**PROPER INSTALLATION IS ESSENTIAL FOR EFFICIENT, TROUBLE-FREE OPERATION OF YOUR FRYER. ANY UNAUTHORIZED ALTERATIONS MADE TO THIS EQUIPMENT WILL VOID THE FRYMASTER WARRANTY.**

Upon arrival, inspect the fryer carefully for visible or concealed damage. (See **Shipping Damage Claim Procedure** in Chapter 1.)

## CLEARANCE AND VENTILATION

**⚠ DANGER**

**No structural material on the fryer should be altered or removed to accommodate placement of the fryer under a hood. Questions? Call the Frymaster/Dean Service Hotline at 1-800-551-8633.**

**⚠ DANGER**

**This appliance must be installed with sufficient ventilation to prevent the occurrence of unacceptable concentrations of substances harmful to the health of personnel in the room in which it is installed.**

The fryer(s) must be installed with a 6" (150 mm) clearance at both sides and back when installed adjacent to combustible construction; no clearance is required when installed adjacent to noncombustible construction. A minimum of 24" (600 mm) clearance should be provided at the front of the fryer.

One of the most important considerations of efficient fryer operation is ventilation. Ensure the fryer is installed so that products of combustion are removed efficiently, and that the kitchen ventilation system does not produce drafts that interfere with proper burner operation.

The fryer flue opening must not be placed close to the intake of the exhaust fan, and the fryer must never have its flue extended in a "chimney" fashion. An extended flue will change the combustion characteristics of the fryer, causing longer recovery time. It also frequently causes delayed ignition. To provide the airflow necessary for good combustion and burner operation, the areas surrounding the fryer front, sides, and rear must be kept clear and unobstructed.

Fryers must be installed in an area with an adequate air supply and adequate ventilation. Adequate distances must be maintained from the flue outlet of the fryer to the lower edge of the ventilation filter bank. Filters should be installed at an angle of 45 degrees. Place a drip tray beneath the lowest edge of the filter. For U.S. installation, NFPA standard No. 96 states, "A minimum distance of 18 inches (450 mm) should be maintained between the flue outlet and the lower edge of the grease filter." Frymaster recommends that the minimum distance be 24 inches (600 mm) from the flue outlet to the bottom edge of the filter when the appliance consumes more than 120,000 BTU per hour.

Information on construction and installation of ventilating hoods can be found in the NFPA standard cited above. A copy of the standard may be obtained from the National Fire Protection Association, Battery March Park, Quincy, MA 02269.

## NATIONAL CODE REQUIREMENTS

The type of gas for which the fryer is equipped is stamped on the data plate attached to the inside of the fryer door. Connect a fryer stamped "NAT" only to natural gas, those stamped "PRO" only to propane gas, and those stamped "MFG" only to manufactured gas.

Installation shall be made with a gas connector that complies with national and local codes, and, where applicable, CE codes. Quick-Disconnect devices, if used, shall likewise comply with national, local, and, if applicable, CE codes.

## ELECTRICAL GROUNDING REQUIREMENTS

All electrically operated appliances must be grounded in accordance with all applicable national and local codes, and, where applicable, CE codes. A wiring diagram is located on the inside of the fryer door. Refer to the rating plate on the inside of the fryer door for proper voltages.

 **DANGER**

**If this appliance is equipped with a three-prong (grounding) plug for your protection against electrical shock, it must be plugged directly into a properly grounded three-prong receptacle. Do not cut, remove, or otherwise bypass the grounding prong on this plug!**

 **DANGER**

**This equipment requires electrical power for operation. Place the gas control valve in the OFF position in case of a prolonged power outage. Do not attempt to use the equipment during a power outage.**

## AUSTRALIAN REQUIREMENTS

To be installed in accordance with AS 5601 / AG 601, local authority, gas, electricity, and any other relevant statutory regulations.

## FCC COMPLIANCE

The user is cautioned that any changes or modifications to Frymaster computers not expressly approved by the party responsible for compliance could void the user's authority to operate the equipment. Frymaster computers have been tested and found to comply with the limits for a Class A digital device, pursuant to Part 15 of the FCC rules. While these devices are verified as Class A devices, they have been shown to meet the Class B limits. These limits are designed to provide reasonable protection against harmful interference when the equipment is operated in a commercial environment. This equipment generates, uses, and can radiate radio frequency energy and, if not installed and used in accordance with the instruction manual, may cause harmful interference to radio communications. Operation of the equipment in a residential area is likely to cause harmful interference in which case the user will be required to correct the interference at the user's expense.

If necessary, the user should consult the dealer or an experienced radio and television technician for additional suggestions.

The user may find the booklet "How to Identify and Resolve Radio-TV Interference Problems" helpful. It is prepared by the Federal Communications Commission and is available from the U.S. Government Printing Office, Washington, DC 20402, Stock No. 004-000-00345-4.

## 2.2 Caster/Leg Installation



**DO NOT install this appliance without legs or casters.**

Depending upon the specific configuration ordered, the fryer might have been shipped without installed casters or legs. If casters or legs are installed, you may skip this section and proceed to Section 2.3, Pre-Connection Preparations.

**If your fryer requires the installation of casters/legs, install them in accordance with the instructions included in your accessory package.**

## 2.3 Pre-Connection Preparations



**Do not connect this appliance to the gas supply before completing each step in this section.**

After the fryer has been positioned under the fry station exhaust hood, ensure the following has been accomplished:

1. Adequate means must be provided to limit the movement of fryers without depending upon the gas line connections. If a flexible gas hose is used, a restraining cable must be connected at all times when the fryer is in use. The restraining cable and installation instructions are packed with the flexible hose in the accessories box that was shipped with your unit.
2. *Single unit* fryers must be stabilized by installing restraining chains on fryers equipped with casters or anchor straps on fryers equipped with legs. Follow the instructions shipped with the casters/legs to properly install the chains or straps.



**Do not attach an apron drain board to a single fryer. The fryer may become unstable, tip over, and cause injury. The appliance area must be kept free and clear of combustible materials at all times.**

Level fryers equipped with legs by screwing out the legs approximately 1 inch, and then adjust them so that the fryer is level and at the proper height in the exhaust hood. Frymaster recommends that the minimum distance from the flue outlet to the bottom edge of the filter be 24 inches (600 mm) when the appliance consumes more than 120,000 BTU per hour.

3. For fryers equipped with casters, there are no built-in leveling devices. The floor where the fryer is to be installed must be level.

4. Test the fryer electrical system:
  - a. Plug the fryer electrical cord(s) into a grounded electrical receptacle.
  - b. Place the power switch in the **ON** position.
    - For fryers equipped with thermostat controls, verify that the power and heat lights are lit.
    - For fryers having computer or digital displays, verify that the display indicates
  - c. Place the fryer power switch in the **OFF** position. Verify that the power and heat lights are out, or that the display is blank.
5. Refer to the data plate on the inside of the fryer door to verify that the fryer burner is configured for the proper type of gas before connecting the gas line quick-disconnect device or piping from the gas supply line.
6. Verify the minimum and maximum gas supply pressures for the type of gas to be used in accordance with the accompanying tables:

<b>Table 1: CE Standard for Incoming Gas Pressures</b>						
<b>Model</b>	<b>Model 35</b>			<b>Model 45</b>		
<b>Gas Type</b>	<b>G20</b>	<b>G25</b>	<b>G31</b>	<b>G20</b>	<b>G25</b>	<b>G31</b>
<b>Pressure (mbar)<sup>1</sup></b>	20	20-25	37-50	20	20-25	37-50
<b>Orifice Size</b>	1,70	1,70	1,05	1,40	1,40	0,86
<b>Number of Orifices</b>	9	9	9	18	18	18
<b>Manifold Pressure</b>	9	13,5	22,5	7,5	10	20,6
<b>Air Flow (m<sup>3</sup>/H)</b>	2,50	3,06	1,51	3,10	3,58	1,80

<sup>1</sup>(mbar) = 10,2 mm CE

<b>Table 2: Non-CE Standard for Incoming Gas Pressures</b>		
<b>Gas</b>	<b>Minimum</b>	<b>Maximum</b>
Natural	6" W.C.	14" W.C.
	1.49 kPa	3.48 kPa
	14.93 mbar	34.84 mbar
LP	11" W.C.	14" W.C.
	2.74 kPa	3.48 kPa
	27.37 mbar	34.84 mbar

7. For fryers equipped with a built-in filter system and/or basket lifts, plug the electrical cord(s) into a power receptacle behind the fryer.

## 2.4 Connection to Gas Line

**⚠ DANGER**

Before connecting new pipe to this appliance, the pipe must be blown out thoroughly to remove all foreign material. Foreign material in the burner and gas controls will cause improper and dangerous operation.

**⚠ DANGER**

When pressure-testing incoming gas supply lines, disconnect the fryer from the gas line if the test pressure will be ½ PSIG (3.45 kPa, 13.84 inches W.C.) or greater to avoid damage to the fryer's gas tubes and gas valve(s).

Performance Pro Series Atmospheric gas fryers (J1C Series excluded) have received the CE mark for the countries and gas categories indicated in Table 3 below.

Country	Category	Gas	Pressure (mbar)
BE	I2E+(S)	G20/G25	20/25
	I3P	G31	37
DE	I2 ELL	G20/G25	20
	I3P	G31	50
DK-GR-IT	I2 H	G20	20
FR	I12Esi3P	G20/G25	20/25
		G31	37 ET 50
LU	I2E	G20/G25	20/25
ES	I12H3P	G20	20
		G31	37 ET 50
NL	I12L3P	G25	25
		G31	50
IE-PT-GB	I12H3P	G20	20
		G31	37

The size of the gas line used for installation is very important. If the line is too small, the gas pressure at the burner manifold will be low. This may cause slow recovery and delayed ignition. The incoming gas supply line should be a minimum of 1½" (38 mm) in diameter. Refer to the Table 4 below for the minimum sizes of connection piping.

Gas	Single Unit	2 - 3 Units	4 Units*
Natural	3/4" (19 mm)	1" (25 mm)	1-1/4" (33 mm)
Propane	1/2" (13 mm)	3/4" (19 mm)	1" (25 mm)
Manufactured	1" (25 mm)	1-1/4" (33 mm)	1-1/2" (38 mm)

\* For distances of more than 20 feet (6 meters) and/or more than four fittings or elbows, increase the connection by one pipe size.



### CE Standard

CE regulations require a combustion air supply of 2m<sup>3</sup>/h per kW per fryer. (See rating plate affixed to door for kW rating.)

1. Connect the quick-disconnect hose to the fryer quick-disconnect fitting under the front of the fryer and to the building gas line.

**NOTE:** Some fryers are configured for a rigid connection to the gas supply line. These units are connected to the gas supply line at the rear of the unit.

When using thread compound, use very small amounts on male threads only. Use a pipe thread compound that is not affected by the chemical action of LP gases (Loctite PST567 sealant is one such compound). DO NOT apply compound to the first two threads. Applying compound to the first two threads will cause clogging of the burner orifices and control valve.

2. Open the gas-supply valve to the fryer and check all piping, fittings, and gas connections for leaks. A soap and water solution should be used for this purpose.

### DANGER

**All connections must be sealed with a joint compound suitable for the gas being used and all connections must be tested with a solution of soapy water before lighting any pilots.**

**Never use matches, candles, or any other ignition source to check for leaks. If gas odors are detected, shut off the gas supply to the appliance at the main shut-off valve and immediately contact the local gas company or an authorized service agency for service.**

3. Close the fryer drain valve and fill the frypot with water and boil-out solution to the bottom OIL-LEVEL line at the rear of the frypot. Light the fryer and perform the boil-out procedures that are described in the "Lighting Instructions" and "Boiling Out the Frypot" topics found in Chapter 3 of this manual.

### DANGER

**"Dry-firing" your unit will cause damage to the frypot and can cause a fire. Always ensure that melted shortening, cooking oil, or water is in the frypot before firing your unit.**

4. The burner manifold pressure should be checked at this time by the local gas company or an authorized service agent. The tables below indicate the proper burner manifold pressures:

Gas	Model 35 Pressure (mbar)	Model 45 Pressure (mbar)
Natural Gas Looq (G20) under 20 mbar	9	7,5
Natural Gas Gronique (G25) under 25 mbar	13,5	10
Natural Gas Gronique (G20) under 20 mbar	13,5	10
Propane (G31) under 37 or 50 mbar	22,5	20,6

Gas	Model 35 Pressure (mbar)	Model 45 Pressure (mbar)
Natural Gas Looq (G20) under 20 mbar	9	7,5
Natural Gas Gronique (G25) under 25 mbar	9	7
Natural Gas Gronique (G20) under 20 mbar	9	10
Propane (G31) under 37 or 50 mbar	22,5	20,6

Gas	Pressure
Natural	3" W.C. 0.73 kPa
LP	8.25" W.C. 2.5 kPa

5. Check the thermostat calibration or temperature programmed into the computer.
- For units equipped with thermostat controls, refer to the Thermostat Calibration instructions in Chapter 5.
  - For units equipped with other types of controllers, refer to the appropriate section of the Frymaster Fryer Controllers User's Manual, provided with your equipment for instructions on programming and operating your controller.

## 2.5 Converting to Another Gas Type

Your fryer is configured at the factory for either natural gas or Propane (LP) gas.

*If you desire to switch from one type of gas to another, a gas conversion kit must be installed by a Factory Authorized Servicer technician.*

### DANGER

**This appliance was configured at the factory for a specific type of gas. Converting from one type of gas to another requires the installation of specific gas-conversion components.**

### DANGER

**Switching to a different type of gas without installing the proper conversion kit may result in fire or explosion! NEVER ATTACH THIS APPLIANCE TO A GAS SUPPLY FOR WHICH IT IS NOT CONFIGURED!**



**DANGER**

**Conversion of this appliance from one type of gas to another should only be performed by qualified, licensed, and authorized installation or service personnel, as defined in Section 1.7 of this manual.**

## CE Gas Conversion Instructions

1. Between G20- and G25-type Natural Gas, adjust the gas pressure at the regulator. (Refer to the CE Standard Burner Manifold Gas Pressure Chart.) Do not change the orifice or pilot.
2. Between a 2<sup>nd</sup> family gas (G20 or G25) and a 3<sup>rd</sup> family gas (G31 Propane):
  - a. Change the orifices.
  - b. Change the pilot.
  - c. Change the gas valve regulator or the gas valve.
  - d. Adjust the manifold pressure.
3. Affix the new label included with the conversion kit next to the existing rating plate stating that the gas type has been converted. Remove any references to the previously used gas from the existing rating plate.
4. If the destination language changes, replace the labels. Call your local service agency or kitchen equipment supplier for a label kit. The language of reference will be on the corner of the label.

The following CE gas-conversion components and kits are available from your FAS:

**Model 35 Only:** There are no CE conversion kits available for the Model 35. Honeywell G31 (propane) gas valves can be adjusted for G20 and G25 (natural) gases, but G20 and G25 gas valves cannot be adjusted for G31. Therefore, if converting from a G20 or G25 gas to G31 gas, in addition to the pilot and orifices, the gas valve must be changed. The table below identifies the parts required to convert from one gas family to another:

**Propane (G31) to Natural (G20/G25)**

Regulator only: P/N 810-1292  
Pilot, regulator, and orifices kits:  
P/N 826-1203 (**Model 45**)

**Natural (G20/G25) to Propane (G31)**

Regulator only: P/N 810-1292  
Pilot, regulator, and orifices kits:  
P/N 826-1202 (**Model 45**)

2 <sup>nd</sup> Family (G20/G25) to 3 <sup>rd</sup> Family (G31)	3 <sup>rd</sup> Family (G31) to 2 <sup>nd</sup> Family (G20/G25)
826-1354 (package of 10 burner orifices)	826-1353 (package of 10 burner orifices)
810-0427 pilot orifices (2 Required)*	810-0426 pilot orifices (2 Required)*
807-2121 CE Gas Valve (Millivolt)	Adjust Gas Valve (No Replacement Required)*
*Quantity required is <b>one</b> unless otherwise noted. Conversion rating label PN 802-2144	

## Non-CE Gas Conversion Instructions

For fryers at elevations at or above 5,000 feet (1524 meters), call Frymaster Service (1-800-551-8633) to determine the components appropriate for your configuration and altitude. Contact your local FAS to order the components and arrange for installation. For fryers below 5000 feet (1524 meters), see the kits listed below for conversion.

### **Natural (G20/G25) to Propane (G31)**

Regulator Conversion Kit: P/N 807-1846

Pilot, regulator conversion kit, and orifices kits:

P/N 826-1139 (**Model 35**)

P/N 826-1143 (**Model 45**)

### **Propane (G31) to Natural (G20/G25)**

Regulator Conversion Kit: P/N 807-1849

Pilot, regulator conversion kit, and orifices kits:

P/N 826-1158 (**Model 35**)

P/N 826-1144 (**Model 45**)

# PERFORMANCE PRO SERIES GAS FRYERS MODELS 35 & 45

## CHAPTER 3: OPERATING INSTRUCTIONS

---

### 3.1 Start-Up Procedure

#### DANGER

Never operate this appliance with an empty frypot. The frypot must be filled with water or cooking oil/shortening before lighting the burners. Failure to do so will damage the frypot and may cause a fire.

#### WARNING

The on-site supervisor is responsible for ensuring that operators are made aware of the inherent hazards of operating a hot oil filtering system, particularly the aspects of oil filtration, draining and cleaning procedures.

#### CAUTION

The cooking oil/shortening capacity of the 35 Series fryer is 35 lbs. (17 liters) at 70°F (21°C). For 45 Series fryers, the capacities are 45 lbs. (22 liters) for a full-vat fryer and 22.5 lbs. (11 liters) for each half of a dual-vat fryer. Before lighting the fryer, make sure the fryer is OFF and the frypot drain valve(s) is/are closed. Remove the basket support rack(s), if installed, and fill the frypot to the bottom OIL LEVEL line. If solid shortening is being used, make sure it is packed down into the bottom of the frypot.

**NOTE:** For units configured as pilot ignition systems, the pilot must be manually lit before the fryer can be placed into operation. On fryers configured with electronic ignition, the pilot is automatically lit when the unit is turned on.

**Ensure that the following steps are done in sequence before lighting or re-lighting the pilot:**

1. Turn the operating thermostat or the solid-state controller to the lowest setting, or turn off the computer/controller.
2. If so equipped, turn off the manual shut-off valve on the incoming gas line.
3. Fill the frypot with oil, liquid shortening or water to the bottom OIL LEVEL line scribed on the frypot back. *If using solid shortening*, pre-melt the shortening prior to filling the frypot.
4. *Non-CE:* Turn the gas valve knob to the OFF position. *CE:* Depress the OFF button (red) on the safety control valve to turn the valve off.
5. Wait at least 5 minutes for any accumulated gas to disperse.
6. If so equipped, turn on the manual shut-off valve on the incoming gas line.

## ACCESSING THE PILOT

In full-vat units, the pilot is mounted on the left side of the burner manifold and is accessed through an opening in the front frypot insulation. In dual-vat units, there is a pilot on both the left and the right halves of the burner manifold. In either case, swing the round cover over the opening out of the way and insert a long match or taper through the hole to light the pilot.

## LIGHTING THE PILOT ON FRYERS WITH STANDARD HONEYWELL GAS VALVES

1. Ensure power to the unit is OFF, then turn the gas valve knob to the OFF position. Wait at least 5 minutes, then rotate the gas valve knob to the PILOT position (see Figure 1).

### Lighting the Pilot

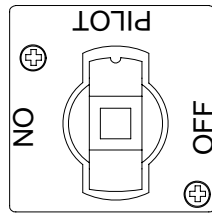

Figure 1

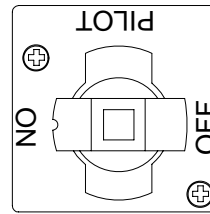

Figure 2

2. Push the knob in and light the pilot. (If the fryer is equipped with a piezo ignitor, repeatedly press the piezo ignitor button while depressing the gas valve knob until the pilot lights.) Continue to hold the knob in for about 60 seconds after the flame appears on the pilot. Release the knob. The pilot should remain lit.

### CAUTION

**If the pilot fails to remain lit, turn the gas valve knob to the OFF position and wait at least five minutes before attempting to re-light.**

3. With the pilot lit, push down and slowly turn the knob to the ON position (see Figure 2 above). Once the pilot has been lit, the burner will automatically light whenever the thermostat is set above its lowest setting or the controller calls for heat.

## LIGHTING THE PILOT ON FRYERS EQUIPPED WITH CE-APPROVED GAS VALVES

1. Ensure power to the unit is OFF, then press the OFF (red) button on the gas valve (see photo below). Wait at least 5 minutes.

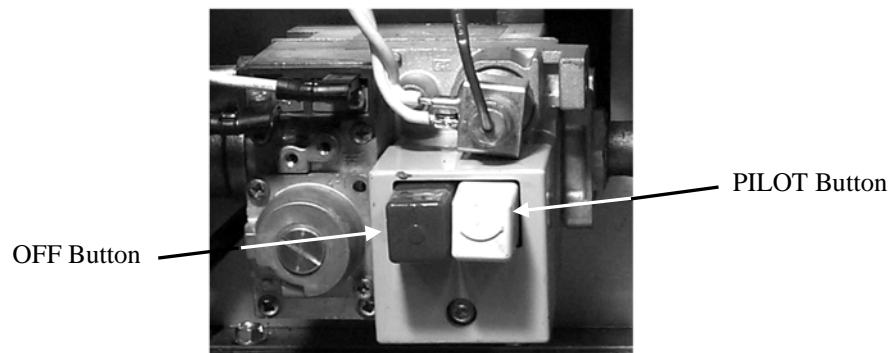

2. *If the fryer is equipped with a piezo ignitor*, press and hold the pilot (white) button, then repeatedly press the piezo ignitor button until the pilot lights.

*If the fryer is NOT equipped with a piezo ignitor*, place a flame near the pilot assembly, push and hold the PILOT (white) button in, light the pilot, and continue to depress the button for at least 60 seconds after the pilot lights.

3. Failure to hold the button in long enough will cause the pilot to go out when the button is released. If the pilot goes out when the button is released, wait at least 5 minutes then repeat this step.

## NOTES ABOUT FRYERS WITH ELECTRONIC IGNITION SYSTEMS

### WARNING

**Never use a match or taper to light the pilot on this ignition system.**

When the computer/controller power switch is placed in the ON position, the ignition module will turn the pilot gas supply on and provide an ignition spark. The spark will light the pilot. A flame sensor verifies the presence of the pilot flame. Unless the pilot flame is sensed, the ignition module will not allow the gas valve to supply gas to the burners. The computer/controller controls the firing of the burners after pilot ignition takes place.

If the pilot flame fails, the ignition module will shut down and “lock out” the system. To restart the system, turn the computer/controller OFF, wait approximately 5 minutes for the system to recycle itself, then turn the computer/controller ON again.

### WARNING

**In the event of prolonged power failure, the ignition module will shut down and “lock out” the system. Turn the computer/controller OFF and then back ON after power has been re-established.**

## PLACING THE FRYER INTO OPERATION

### CAUTION

**If this is the first time the fryer is being used after installation, refer to Section 3.2, Boil-Out Procedure.**

**For units equipped with Thermostat Controls:**

Place the Melt Cycle switch (if so equipped) to the ON position and set the thermostat knob to the desired cooking temperature. The U-shaped burner should ignite and burn with a strong, blue flame.

### CAUTION

**Thermostat-controlled fryers equipped with Melt Cycle switches will stay in the Melt Cycle mode until the Melt Cycle Switch is placed in the OFF position.**

### For units equipped with other than Thermostat Controls:

Place the computer/controller ON/OFF switch in the ON position and set the controller to – or program the controller for – the desired cooking temperature, referred to as the *setpoint*. The U-shaped burner will light and burn with a strong, blue flame. The unit automatically enters the Melt Cycle mode if the frypot temperature is below 180°F (82°C). (**NOTE:** During the melt cycle, the burner will repeatedly fire for a few seconds, then go out for a longer period.) When the frypot temperature reaches 180°F (82°C), the unit will automatically switch to the Heating mode. The burner will remain lit until the frypot temperature reaches the programmed cooking temperature (setpoint).

## 3.2 Boiling-Out the Frypot

To ensure that the frypot is free of any contamination resulting from its manufacture, shipping, and handling during installation, the frypot must be boiled out before first use. Frymaster recommends boiling out the frypot each time the oil or shortening is changed.

### DANGER



**Never leave the fryer unattended during the boil-out process. If the boil-out solution boils over, turn the fryer off immediately and let the solution cool for a few minutes before resuming the process. To lessen the chance of boil over, turn the fryer's gas valve knob to the PILOT position occasionally.**

1. Before lighting the burner, close the fryer drain valve(s) and fill the frypot to the bottom OIL-LEVEL line with a mixture of cold water and automatic dishwasher liquid.
2. For units equipped with a *Thermostat or Solid State (Analog) Controller*, set the thermostat to 195°F (91°C).

For units equipped with a *Digital Controller*, set the setpoint to 195°F (91°C).

For units equipped with a *Basket Lift Timer*, press the Boil-Out Mode button  to begin the boil-out process.

For units equipped with a *Computer Magic III.5 Computer*,

- Press the Power switch  followed by the Program Mode switch . Code will appear in the left display.
- Enter the code number 1653. The right display will read **BOIL**. The temperature is automatically set for 195°F (91°C). The fryer will attain this temperature and remain there until the Power  switch is pressed, which cancels the boil-out mode.

3. Place the fryer into operation in accordance with Section 3.1.
4. Simmer the solution for 1 hour.
5. After the solution simmers for 1 hour, turn the fryer off, allow the solution to cool, then add 2 gallons (8 liters) of cold water and stir. Drain the solution into a suitable container and clean the frypot thoroughly.



 **WARNING**

**Do not drain boil-out solution into a shortening disposal unit, a built-in filtration unit, or a portable filter unit. These units are not intended for this purpose, and will be damaged by the solution.**

6. Rinse the frypot at least twice by filling the frypot with clean water and draining. Dry the frypot thoroughly with a clean, dry towel.

 **DANGER**

**Remove all drops of water from the frypot before filling with cooking oil or shortening. Failure to do so will cause spattering of hot liquid when the oil or shortening is heated to cooking temperature and may cause injury to nearby personnel.**

### **3.3 Shutting the Fryer Down**

For short-term shut down during the workday, place the fryer power switch in the "OFF" position and put the frypot covers in place (if the fryer is so equipped).

When shutting the fryers down at closing time, place the fryer power switch in the "OFF" position, place the gas valve in the "OFF" position, and put the frypot covers in place (if the fryer is so equipped).

### **3.4 Controller Operation and Programming**

Fryers in the Performance Pro Series can be equipped with Computer Magic III.5 (CM III.5) computers, Basket Lift Timers, Digital Controllers, Solid State (Analog) Controllers, or Thermostat Controllers. Instructions for using each type are included in the separate *Frymaster Fryer Controllers User's Manual* provided with your equipment.

# PERFORMANCE PRO SERIES GAS FRYERS MODELS 35 & 45

## CHAPTER 4: FILTRATION INSTRUCTIONS

---

### WARNING

The on-site supervisor is responsible for ensuring that operators are made aware of the inherent hazards of operating a hot oil filtering system, particularly the aspects of oil filtration, draining and cleaning procedures.

#### 4.1 Draining and Manual Filtering

### DANGER

Draining and filtering of cooking oil or shortening must be accomplished with care to avoid the possibility of a serious burn caused by careless handling. The oil to be filtered is at or near 350°F (177°C). Ensure all hoses are connected properly and drain handles are in their proper position before operating any switches or valves. Wear all appropriate safety equipment when draining and filtering cooking oil or shortening.

### DANGER

Allow oil/shortening to cool to 100°F (38°C) before draining into an appropriate container for disposal.

### DANGER

Do not drain more than one frypot at a time into the built-in filtration unit to avoid overflow and spillage of hot oil/shortening.

### DANGER

When draining oil/shortening into a disposal unit or portable filter unit, do not fill above the maximum fill line located on the container.

If your fryer is not equipped with a built-in filtration system, the cooking oil or shortening must be drained into another suitable container. (For safe, convenient draining and disposal of used cooking oil or shortening, Frymaster recommends using the Frymaster Shortening Disposal Unit (SDU). The SDU is available through your local distributor.)

1. Turn the fryer power switch to the **OFF** position. Screw the drainpipe (provided with your fryer) into the drain valve. Make sure the drainpipe is firmly screwed into the drain valve and that the opening is pointing down.
2. Position a metal container with a sealable cover under the drainpipe. The metal container must be able to withstand the heat of the cooking oil/shortening and hold hot liquids. If you intend to reuse the oil or shortening, Frymaster recommends that a Frymaster filter cone holder and filter cone be used when a filter machine is not available. If you are using a Frymaster filter cone holder, be sure that the cone holder rests securely on the metal container.

3. Open the drain valve slowly to avoid splattering. If the drain valve becomes clogged with food particles, use the Fryer's Friend (poker-like tool) to clear the blockage.

** DANGER**

**NEVER attempt to clear a clogged drain valve from the front of the valve! Hot oil or shortening will rush out creating the potential for severe burns.**

**DO NOT hammer on the drain valve with the cleanout rod or other objects. Damage to the ball inside will result in leaks and will void the Frymaster warranty.**

4. After draining the oil/shortening, clean all food particles and residual oil/shortening from the frypot. BE CAREFUL, this material may still cause severe burns if it comes in contact with bare skin.
5. Close the drain valve securely and fill the frypot with clean, filtered or fresh cooking oil or solid shortening to the bottom OIL-LEVEL line.

** DANGER**

**When using solid shortening, pack the shortening down into the bottom of the frypot. DO NOT operate the fryer with a solid block of shortening sitting in the upper portion of the frypot. This will cause damage to the frypot and may cause a flash fire.**

## **4.2 Preparing the Built-In Filtration System for Use**

The FootPrint Pro filtration system allows the cooking oil or shortening in one frypot to be safely and efficiently filtered while the other frypots in a battery remain in operation. The FootPrint Pro filtration system is available in three different configurations:

- Filter Paper – includes crumb screen, large hold-down ring, and metal filter screen.
- Filter Pad – includes crumb screen, small hold-down ring, and metal filter screen.
- Magnasol Filter – includes crumb screen and Magnasol filter assembly.

Section 4.2.1 covers preparation of the Filter Paper and Filter Pad configurations for use. Refer to Section 4.2.2 for instructions on preparing the Magnasol Filter configuration for use. Operation of all three configurations is the same and is covered in section 4.3. Disassembly and reassembly of the Magnasol filter is covered in section 4.4.

## 4.2.1 Preparation for Use with Filter Paper or Filter Pad

1. Pull the filter pan out from the cabinet and remove the crumb screen, hold-down ring, and filter screen.

The filter pan is equipped with rollers in rails, much like a kitchen drawer. The pan may be removed for cleaning or to gain access to interior components by lifting the front of the pan to disengage the front rollers, then pulling it forward until the rear rollers clear the rails. The pan cover must not be removed except for cleaning, interior access, or to allow a shortening disposal unit (SDU) to be positioned under the drain.

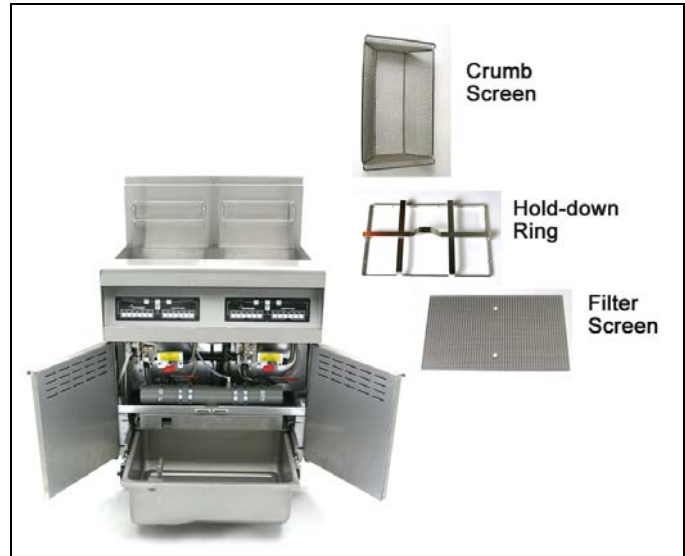

**Remove the crumb screen, hold-down ring, and filter screen from the pan. Clean all components with a solution of detergent and hot water, then dry thoroughly.**

2. Inspect the filter pan connection fitting to ensure that both O-rings are in good condition.

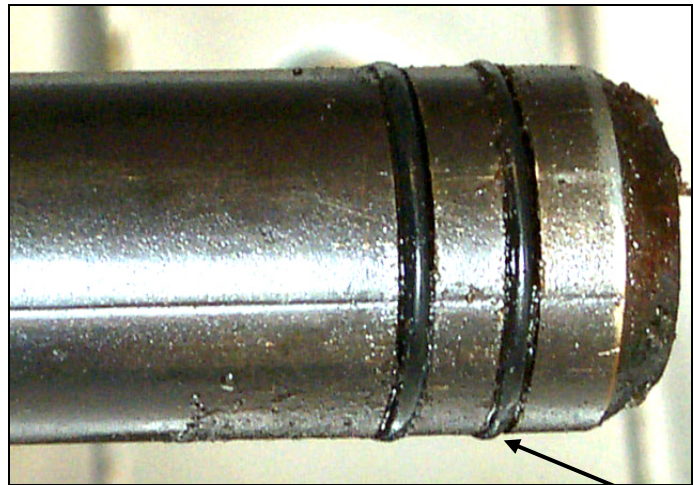

**Inspect the filter connection fitting O-rings.**

3. Place the metal filter screen in the center of the bottom of the pan.



**Place the filter screen in the bottom of the filter pan.**

4. Lay a sheet of filter paper over the screen, overlapping on all sides, or, if using a filter pad, lay the pad over the screen.



**Lay a sheet of filter paper or a filter pad over the screen. If using the PAD, ensure the rough side of the pad is up.**

5. Install the hold-down ring over the paper or the pad.



**If using filter paper, position the hold-down ring over the filter paper and lower the ring into the pan, allowing the paper to fold up around the ring as it is pushed to the bottom of the pan. When the hold-down ring is in position, sprinkle one cup of filter powder evenly over the paper.**

**If using a filter pad, position the hold-down ring on top of the pad. DO NOT use filter powder with the pad.**

6. Replace the crumb screen in the filter pan, then push the filter pan back into the fryer, positioning it all the way to the back of the cabinet.



## 4.2.2 Preparation for Use with the Magnasol Filter Assembly

1. Pull the filter pan out from the cabinet and remove the crumb screen and Magnasol filter assembly.

The filter pan is equipped with rollers in rails, much like a kitchen drawer. The pan may be removed for cleaning or to gain access to interior components by lifting the front of the pan to disengage the front rollers, then pulling it forward until the rear rollers clear the rails. The pan cover must not be removed except for cleaning, interior access, or to allow a shortening disposal unit (SDU) to be positioned under the drain.

**NOTE:** Refer to Section 4.4 for instructions on how to disassemble and reassemble the Magnasol filter screen assembly.



**Remove the crumb screen and filter assembly from the pan. Clean all components with a solution of detergent and hot water, then dry thoroughly.**

2. Inspect the fitting on the bottom of the Magnasol filter assembly to ensure that the O-ring is present and in good condition.



**Inspect the filter screen O-ring.**

3. Inspect the filter pan connection fitting to ensure that both O-rings are present and in good condition.

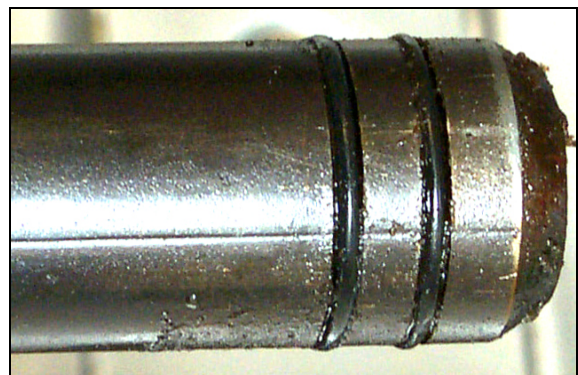

**Inspect the filter connection fitting O-rings.**

4. Replace the Magnasol filter assembly in the filter pan.



Replace the filter assembly in the filter pan, ensuring that the fitting on the bottom of the assembly is securely seated in the port in the bottom of the pan. Sprinkle one cup of Magnasol XL filter powder evenly over the screen.

5. Replace the crumb screen, then push the filter pan back into the fryer, positioning it all the way to the back of the cabinet.

### 4.3 Operation of the Filter

#### **⚠ DANGER**

Draining and filtering of cooking oil or shortening must be accomplished with care to avoid the possibility of a serious burn caused by careless handling. The oil to be filtered is at or near 350°F (177°C). Ensure drain handles are in their proper position before operating any switches or valves. Wear all appropriate safety equipment when draining and filtering cooking oil or shortening.

#### **⚠ DANGER**

**NEVER** attempt to drain cooking oil or shortening from the fryer with the burners lit! Doing so will cause irreparable damage to the frypot and may cause a flash fire. Doing so will also void the Frymaster warranty.

1. Turn the fryer power OFF. Drain **ONE** of the frypots into the filter pan. If necessary, use the *Fryer's Friend* clean-out rod to clear the drain from **inside** the frypot.



Rotate **ONE** of the drain valve handles to the left to open a drain valve.

**⚠ DANGER**

**Do not drain more than one frypot at a time into the built-in filtration unit to avoid overflow and spillage of hot oil/shortening.**

**⚠ DANGER**

**NEVER attempt to clear a clogged drain valve from the front of the valve! Hot oil or shortening will rush out creating the potential for severe burns.**

**DO NOT hammer on the drain valve with the cleanout rod or other objects. Damage to the ball inside will result in leaks and will void the Frymaster warranty.**

2. If present, install the optional Power Shower. **NOTE:** Verify that the Power Shower O-ring and gasket are present and in good condition and that the clean-out screws are installed at each corner. If the frypot is front flush, there are no accessories to install.

Install the Power Shower in the frypot to be filtered.

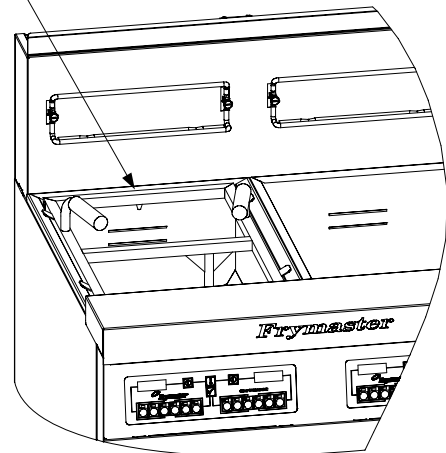

**Snap the Power Shower into position.**

**⚠ DANGER**

**DO NOT operate the filter without the Power Shower in place. Hot oil will spray out of the fryer and cause injury.**

3. After the cooking oil has drained from the frypot, rotate the Oil Return handle left to the RETURN position to start the pump and begin the filtering process. There may be a slight delay before the pump activates. On fryers equipped with an optional rear- discharge system (See Section 4.6), rotating the handle to the right will discharge the oil.

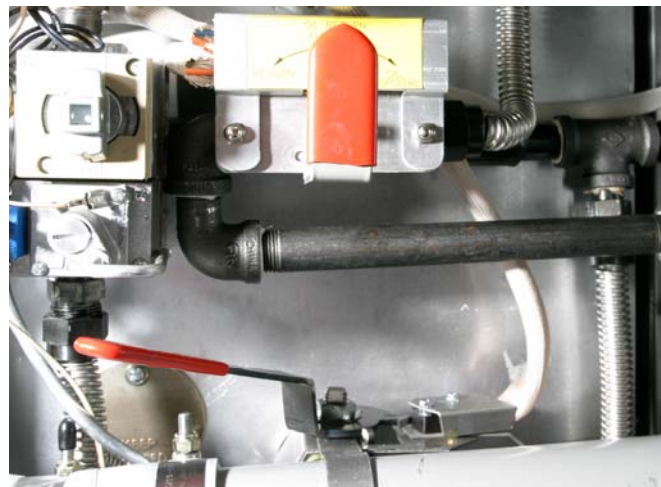

Rotate the handle to the left to return oil to the frypot. Rotate to the right on fryers with optional rear-discharge to dispose of the oil.



- The filter pump draws the cooking oil/shortening through the filter medium and circulates it back up to and through the frypot during a 5-minute process called polishing. Polishing cleans the oil by trapping solid particles in the filter medium.
- After the oil is filtered (about 5 minutes), close the drain valve and allow the fryer to refill. Let the filter pump run 10 to 12 seconds after the oil begins to sputter from the Power Shower openings. Turn the filter off, remove the Power Shower and let it drain.

**⚠ WARNING**

The filter pump is equipped with a manual reset switch in case the filter motor overheats or an electrical fault occurs. If this switch trips, turn off power to the filter system and allow the pump motor to cool 20 minutes before attempting to reset the switch (see photo below). To access the switch, reach in from the front of the fryer.



**Filter Pump Reset Switch (Arrow)**

- Ensure the drain valve is fully closed. (If the drain valve is not fully closed, the fryer will not operate.) Turn the fryer ON and allow the cooking oil/shortening to reach setpoint.

**⚠ DANGER**

The crumb screen in fryers equipped with a filter system must be emptied into a fireproof container at the end of frying operations each day. Some food particles can spontaneously combust if left soaking in certain shortening material.

**⚠ WARNING**

Do not bang fry baskets or other utensils on the fryer's joiner strip. The strip is present to seal the joint between the fry vessels. Banging fry baskets on the strip to dislodge shortening will distort the strip, adversely affecting its fit. It is designed for a tight fit and should only be removed for cleaning.

## 4.4 Disassembly and Reassembly of the Magnasol Filter

### Dissassembly

1. Grasp the frame with your thumbs on the handles at the corner of the assembly and pull outward in opposite directions to separate the frame at the corner. Continue to open the frame (it will pivot at the opposite corner) until the outer screens and grid can be removed from the frame.

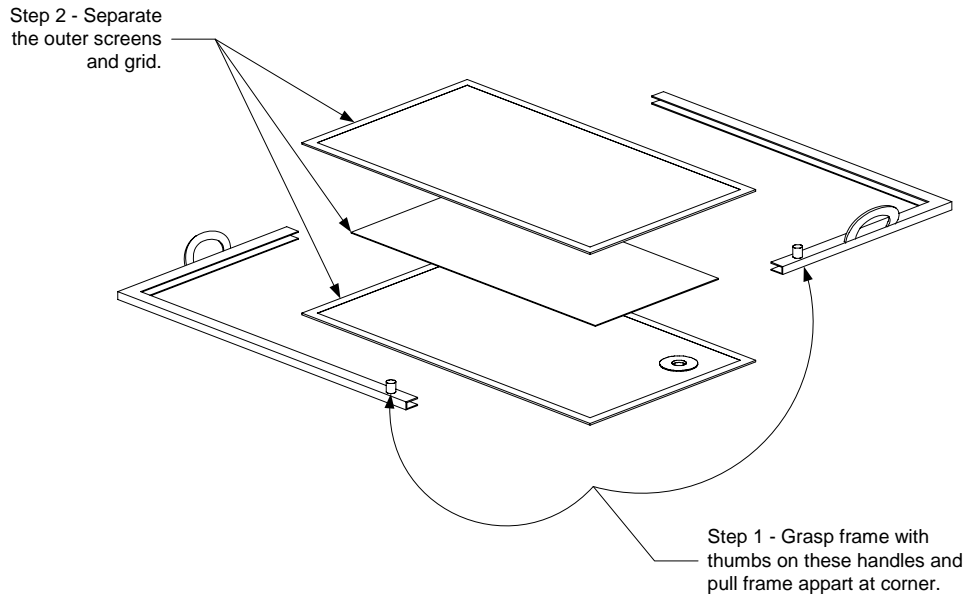

2. Separate the outer screens and grid.

### Cleaning

1. Daily – Clean the outer screens, grid, and frame using a good quality degreaser and hot water from a spray nozzle. The groove in the seal frame pieces can be cleaned with the edge of a Scotch-Brite™ or similar cleaning pad.

Allow all filter assembly components to air dry or thoroughly dry with clean towels before reassembling.

2. Additionally, at each scheduled boil-out, disassemble the leaf filter assembly and place in the frypot being boiled out. Follow the boil-out procedure in Section 5.1.2 of this manual.

### Reassembly

1. Place the two outer screens together and align their edges (see illustration on following page).
2. Insert the screens into one of the frame halves (it doesn't matter which one). Ensure that the fitting in the bottom screen is on the opposite side of the frame from the handle.
3. Slip the grid between the screens, ensuring that the grid is centered between the edges of the screens.
4. Connect the other half of the frame at the corner opposite the handles and pivot the frame onto the free edges of the screen.

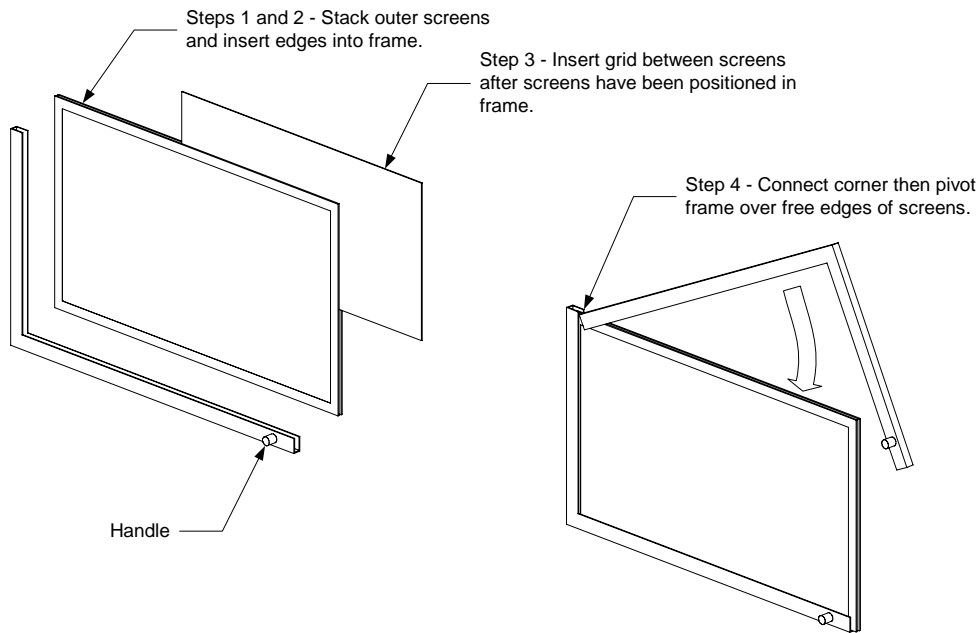

## 4.5 Draining and Disposing of Waste Oil

When your cooking oil/shortening has reached the end of its usable life, drain the oil/shortening into an appropriate container for transport to the disposal container. Frymaster recommends the use of the Frymaster Shortening Disposal Unit (SDU). **NOTE:** The filter pan lid must be removed from the fryer to allow the SDU to fit under the drain. To remove the lid, lift up on the front edge and pull it straight out of the cabinet. Refer to the documentation furnished with your disposal unit for specific operating instructions. If a shortening disposal unit is not available, allow the oil/shortening to cool to 100°F (38°C), then drain the oil or shortening into a metal stockpot or similar metal container. When draining is finished, close the fryer drain valve securely.

### DANGER

**Allow oil/shortening to cool to 100°F (38°C) before draining into an appropriate container for disposal. When draining oil/shortening into a disposal unit, do not fill above the maximum fill line located on the container.**

## 4.6 Disposing of Oil with Optional Rear Discharge

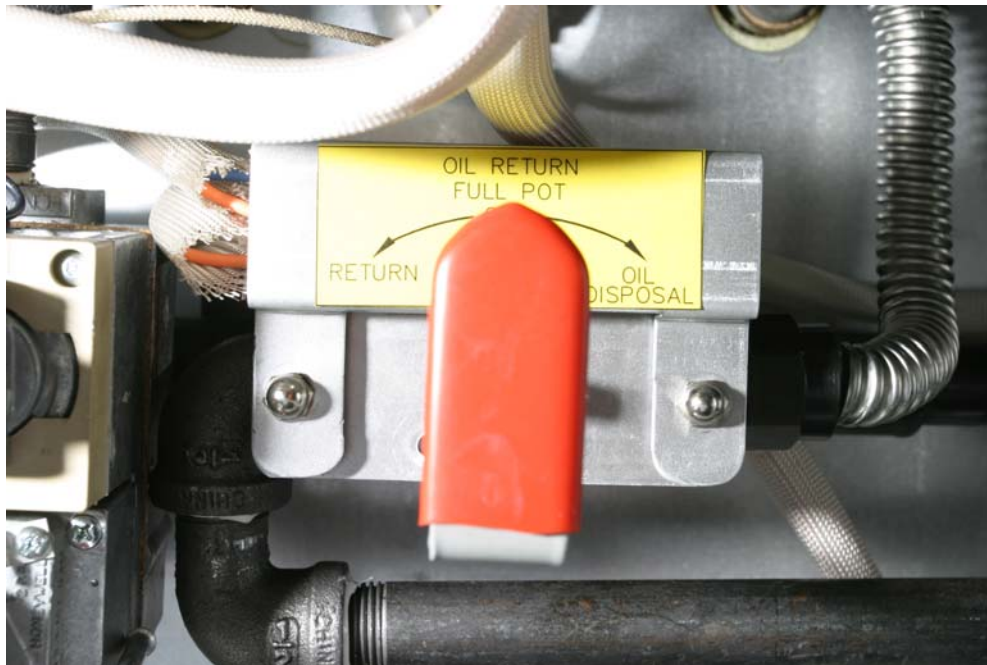

Turn the handle to the left to return oil from the filter pan to the frypot.  
Turn it to the right to discharge the oil to the disposal system.

1. Ensure the filter pan is clean and prepared for filtration. Prepare the filter pan if necessary. **DO NOT** discharge oil through a dirty or incomplete filter pan.
2. With the oil at operating temperature, turn the fryer off. Wear protective clothing and use caution. Hot oil can cause serious injuries.
3. Drain the oil into the filter pan by opening the drain valve. **Drain only one vat at a time.** Close the drain valve. Ensure all drain valves are closed.
4. Ensure the oil disposal reservoir is not full and the fryer is properly connected to the oil disposal system.
5. Rotate the filter valve handle to the Oil Disposal position. See illustration above. The oil will be pumped from the filter pan to the oil disposal reservoir. Do not discharge water or other liquids through the filter system.
6. Return the filter handle to the upright OFF position when the filter pan empties.
7. Repeat steps for other fry vats as necessary.
8. Refill fryer with fresh oil.

# PERFORMANCE PRO SERIES GAS FRYERS MODELS 35 & 45

## CHAPTER 5: PREVENTATIVE MAINTENANCE

---

### 5.1 Fryer Preventive Maintenance Checks and Services

#### DAILY CHECKS AND SERVICES

##### Inspect Fryer and Accessories for Damage

Look for loose or frayed wires and cords, leaks, foreign material in frypot or inside cabinet, and any other indications that the fryer and accessories are not ready and safe for operation.

Inspect the ceramic burner targets. Ensure the targets are in position above each orifice, and that the flame ignites approximately 2-½ inches (60 mm) above the orifice. The flame should strike the center of the target and be a rich blue color. Call your Factory Authorized Servicer (FAS) if you see any problems.

##### Clean Fryer Cabinet Inside and Out

 **DANGER**

**Never attempt to clean the fryer during the cooking process or when the frypot is filled with hot oil/shortening. If water comes in contact with oil/shortening heated to cooking temperature, it can cause spattering, which can result in severe burns to nearby personnel.**

 **WARNING**

**Use a commercial-grade cleaner formulated to effectively clean and sanitize food-contact surfaces. Read the directions for use and precautionary statements before use. Particular attention must be paid to the concentration of cleaner and the length of time the cleaner remains on the food-contact surfaces.**

Clean inside the fryer cabinet with dry, clean cloth. Wipe all accessible metal surfaces and components to remove accumulations of oil or shortening and dust.

Clean the outside of the fryer cabinet with a clean, damp cloth soaked with dishwashing detergent, removing oil/shortening, dust, and lint from the fryer cabinet.

##### Filter Cooking Oil/Shortening

The cooking oil/shortening used in your fryer should be filtered at least once every day (more often if the fryer is in constant use). Refer to Chapter 4, Filtration Instructions, for details.

## WEEKLY CHECKS AND SERVICES

### Check Recovery Time (Fryers with Computers Only)

Recovery Time is the amount of time it takes the fryer to increase the frypot temperature from 275°F (135°C) to 325°F (163°C). It is a measure of the fryer's efficiency, and should be no more than 2 minutes and 30 seconds for MJP35 and MJP45 model fryers, and 3 minutes and 30 seconds for MJPCF Series fryers. The recovery time on models having CM III.5 computers is automatically measured by the computer.

To view the recovery time on models equipped with CM III.5 computers, press the Program Mode switch . **Code** will appear in the left display. Enter the code number  (1652) on the number keys. The latest recovery time will appear in both displays for 5 seconds.

## QUARTERLY CHECKS AND SERVICES

### Drain and Clean Frypot

During normal usage of your fryer, a deposit of carbonized cooking oil or shortening will gradually form on the inside of the frypot. This deposit must be periodically removed to maintain your fryer's efficiency.



**Allow oil/shortening to cool to 100°F (38°C) or lower before draining to an appropriate container for disposal.**

If your fryer is not equipped with the built-in FootPrint Pro system, the cooking oil or shortening must be drained into another suitable container. For safe, convenient draining and disposal of used cooking oil or shortening, Frymaster recommends the use of our shortening disposal unit (SDU). The SDU is available through your local distributor.

### Clean Detachable Parts and Accessories

As with the frypot, a deposit of carbonized oil/shortening will accumulate on detachable parts and accessories such as baskets, sediment trays, or fishplates

Wipe all detachable parts and accessories with a clean cloth dampened with a detergent solution. Rinse and thoroughly dry each part.

### Check Calibration of Thermostat/Solid State (Analog) Controller Temperature Control Knob

**(NOTE:** This check applies only to units equipped with Thermostat or Solid State (Analog) Controllers.)

1. Ensure frypot is filled with cooking oil or melted shortening.
2. Set the temperature control knob to frying temperature.

3. Let the burner cycle on and off automatically three times in order for the cooking oil/shortening temperature to become uniform. If necessary, stir to get all shortening in the bottom of the frypot melted.
4. Insert a good-grade thermometer or pyrometer probe into the oil/shortening, with the end touching the fryer temperature probe.
5. When the burner starts for the fourth time, the thermometer/pyrometer reading should be within  $\pm 5^{\circ}\text{F}$  ( $2^{\circ}\text{C}$ ) of the temperature knob setting. If not, calibrate as follows:
  - a. Loosen the setscrew in the temperature control knob until the knob rotates freely on the shaft.
  - b. Rotate the knob until the index line on the knob is aligned with the marking that corresponds to the thermometer or pyrometer reading.
  - c. Hold the knob and tighten the setscrew.
  - d. Recheck the thermometer/pyrometer reading against the temperature control knob setting the next time the burner comes on.
  - e. Repeat steps 4.a. through 4.d. until the thermometer/pyrometer reading and knob setting are within  $\pm 5^{\circ}\text{F}$  ( $2^{\circ}\text{C}$ ).

**If calibration is not possible, contact a Factory Authorized Servicer for service.**

#### **Check Thermostat Controller Thermostat Calibration**



**(NOTE:** This check applies only to units equipped with Thermostat Controllers)

1. Ensure frypot is filled with cooking oil or shortening.
2. Set the temperature control knob to  $325^{\circ}\text{F}$  ( $162^{\circ}\text{C}$ ) and insert a good grade thermometer or pyrometer into the frypot so that it touches the temperature probe guard.
3. When the burner cycles off, set the temperature control knob to  $340^{\circ}\text{F}$  ( $170^{\circ}\text{C}$ ). As the reading on the thermometer or pyrometer nears the control knob setting, but before the burner cycles off, reset the knob to  $325^{\circ}\text{F}$  ( $162^{\circ}\text{C}$ ). Just as the reading on the thermometer or pyrometer drops below  $325^{\circ}\text{F}$  ( $162^{\circ}\text{C}$ ), the burner should cycle on. If it does not, calibration is required. Contact a Factory Authorized Servicer (FAS) for service.

#### **Check Computer Magic III.5 Set Point Accuracy**

**(NOTE:** This check applies only to units equipped with Computer Magic III.5 Controllers.)

1. Insert a good-grade thermometer or pyrometer into the oil/shortening, with the end touching the fryer temperature probe.

2. When the computer displays - - - - with no red dot between the first and second dashes (indicating that the frypot contents are within the cooking range), press the  switch once to display the temperature of the cooking oil or shortening as sensed by the temperature probe.
3. Press the  switch twice to display the set point.
4. Note the temperature on the thermometer or pyrometer. All three readings should be within  $\pm 5^{\circ}\text{F}$  ( $2^{\circ}\text{C}$ ) of each other. If not, contact a Factory Authorized Servicer for assistance.

### Clean Gas Valve Vent Tube

1. Carefully unscrew the vent tube from the valve. (**NOTE:** The vent tube may be straightened for easier removal.)
2. Pass a piece of ordinary binding wire (.052 inch diameter) through the tube to remove any obstruction.
3. Remove the wire and blow through the tube to ensure it is clear.
4. Reinstall tube and bend it so that the opening is pointing downward.

## SEMI-ANNUAL CHECKS AND SERVICES

### Check Burner Manifold Pressure

 **DANGER**

**This task should be performed by qualified service personnel only. Contact FAS to arrange this service.**

 **WARNING**

**Do not run water or boil-out solution through the filtration system. Doing so will cause irreparable damage to the pump, and the warranty will be voided.**

### 5.2 FootPrint Pro Filtration System Preventive Maintenance Checks and Services

There are no periodic preventive maintenance checks and services required for your FootPrint Pro Filtration System other than daily cleaning of the filter pan, screen, and hold-down ring with a solution of hot water and detergent. **Always remove the filter pan assembly from the fryer before cleaning with hot water and detergent. After rinsing, turn the filter pan upside down and slightly elevate the end to allow all water to drain from the suction tube. Ensure the pan is dried thoroughly before returning to service.**

If you notice that the system is pumping slowly or not at all, verify that the filter pan screen is on the bottom of the filter pan, with the paper on top of the screen. If the filter screen and paper are correctly installed, change the filter paper and verify that the O-rings on the connection fitting are present and in good condition. **NOTE:** With fresh paper and properly installed O-rings, the system should refill the fryer in 2 to 3 minutes.



Immediately after each use, drain the Power Shower completely. If you suspect blockage, unscrew the clean-out plugs at each corner of the frame. Place the frame in a pan of hot water for several minutes to melt any accumulation of solidified oil/shortening. Use a long, narrow bottlebrush with hot water and detergent to clean inside the tubes. If necessary, insert a straightened paper clip or similar instrument into the holes in the frame to remove any blockages. Rinse, dry thoroughly, and reinstall the plugs before using.

 **DANGER**

**Failure to reinstall the Power Shower cleanout plugs will allow hot oil to spray out of the frypot during the filtering process, creating a burn hazard to personnel.**

### 5.3 ANNUAL/PERIODIC SYSTEM INSPECTION

**This appliance should be inspected and adjusted periodically by qualified service personnel as part of a regular kitchen maintenance program.**

**Frymaster recommends that this appliance be inspected at least annually by a Factory Authorized Servicer Technician as follows:**

#### **Fryer**

- Inspect the cabinet inside and out, front and rear for excessive oil build-up and/or oil migration.
- Verify that the flue opening is not obstructed by debris or accumulations of solidified oil or shortening.
- Verify that burners and associated components (i.e. gas valves, pilot assemblies, ignitors, etc.) are in good condition and functioning properly. Inspect all gas connections for leaks and verify that all connections are properly tightened.
- Verify that the burner manifold pressure is in accordance with that specified on the appliance's rating plate.
- Verify that the temperature and high-limit probes are properly connected, tightened and functioning properly, and that probe guards are present and properly installed.
- Verify that component box components (i.e. computer/controller, transformers, relays, interface boards, etc.) are in good condition and free from oil migration build-up and other debris. Inspect the component box wiring and verify that connections are tight and that wiring is in good condition.
- Verify that all safety features (i.e. drain safety switches, reset switches, etc.) are present and functioning properly.
- Verify that the frypot is in good condition and free of leaks and that the frypot insulation is in serviceable condition. Verify that the frypot tube diffusers are present and in good condition (i.e. no visible deterioration or damage).
- Verify that wiring harnesses and connections are tight and in good condition.

## Built-In Filtration System

- Inspect all oil-return and drain lines for leaks and verify that all connections are tight.
- Inspect the filter pan for leaks and cleanliness. If there is a large accumulation of crumbs in the crumb basket, advise the owner/operator that the crumb basket should be emptied into a fireproof container and cleaned daily.
- Verify that all O-rings and seals (including those on the Power Shower and on quick-disconnect fittings) are present and in good condition. Replace O-rings and seals if worn or damaged.
- Check filtration system integrity as follows:
  - With the filter pan empty, place each oil return handle, one at a time, in the ON position. Verify that the pump activates and that bubbles appear in the cooking oil/shortening (or that gurgling is heard from the Power Shower port) of the associated frypot.
  - Close all oil return valves (i.e., place all oil return handles in the OFF position). Verify proper functioning of each oil return valve by activating the filter pump using the lever on one of the oil return handle microswitches. No air bubbles should be visible in any frypot (or no gurgling should be heard from the Power Shower ports).
  - Verify that the filter pan is properly prepared for filtering, then drain a frypot of oil heated to 350°F (177°C) into the filter pan and close the frypot drain valve. Place the oil return handle in the ON position. Allow all cooking oil/shortening to return to the frypot (indicated by bubbles in the cooking oil/shortening or, on units with Power Showers, cessation of oil flow from the Power Shower). Return the oil return handle to the OFF position. The frypot should have refilled in no more than 2 minutes and 30 seconds.

# PERFORMANCE PRO SERIES GAS FRYERS MODELS 35 & 45

## CHAPTER 6: OPERATOR TROUBLESHOOTING

---

### 6.1 Introduction

This chapter provides an easy reference guide to the more common problems that may occur during the operation of your equipment. The troubleshooting guides in this chapter are intended to help you correct, or at least accurately diagnose, problems with your equipment. Although the chapter covers the most common problems reported, you may very well encounter a problem not covered. In such instances, the Frymaster Technical Service Department will make every effort to help you identify and resolve the problem. Also, the troubleshooting guides may not be applicable to certain models.

When troubleshooting a problem, always use a process of elimination starting with the simplest solution and working through to the most complex. Never overlook the obvious. Anyone can forget to plug a cord into a receptacle or put a piece of filter paper into a filter pan. Don't assume that you are exempt from such occurrences.

Most importantly, always try to establish a clear idea of why a problem has occurred. Part of your corrective action involves taking steps to ensure that it doesn't happen again. If a controller malfunctions because of a poor connection, check all other connections while you're at it. If a fuse continues to blow, find out why. Always keep in mind that failure of a small component may often be indicative of potential failure or incorrect functioning of a more important component or system.

If you are in doubt as to the proper action to take, do not hesitate to call the Frymaster Technical Service Department or your local Frymaster Factory Authorized Servicer for assistance.

 **DANGER**

**Hot cooking oil/shortening will cause severe burns. Never attempt to move this appliance when filled hot cooking oil/shortening or to transfer hot cooking oil/shortening from one container to another.**

 **DANGER**

**This equipment should be unplugged when servicing, except when electrical circuit tests are required. Use extreme care when performing such tests.**

**This appliance may have more than one electrical power supply connection point. Disconnect all power cords before servicing.**

**Inspection, testing, and repair of electrical components should be performed by an authorized service agent only.**

**6.2 Troubleshooting Fryers with Solid State (Analog), Digital or CM III.5 Controllers**

<b>PROBLEM</b>	<b>PROBABLE CAUSES</b>	<b>CORRECTIVE ACTION</b>
<b>Burner will not light.</b>	A. Pilot not lit.	A. Light pilot per instructions in Chapter 3 of this manual.
	B. Drain valve open.	B. Verify that drain valve is fully closed.
	C. No electrical power to unit.	C. Verify that unit is plugged in and that circuit breaker is not tripped.
	D. No gas being supplied to unit.	D. Verify that the gas line connections are properly connected, that any cutoff valves between the fryer and the gas main are open, and that the main gas cutoff valve is open.
	E. Failed controller.	E. If available, substitute controller known to be good for suspect controller. If fryer operates normally, order replacement controller from FAS.
<b>Solid state (analog) controller power and trouble lights on, but heat light is not,</b>  <b>OR</b>  <b>CM III.5 display shows <i>Pr ob.</i></b>	Failed controller.  Failed temperature probe.	If available, substitute controller known to be good for suspect controller. If fryer operates normally, order replacement controller from FAS. If the fryer doesn't operate properly, have the temperature probe circuit tested. Call FAS.
<b>Unit stays in melt cycle continuously.</b>	Failed controller.  Failed temperature probe.	If available, substitute controller known to be good for suspect controller. If fryer operates normally, order replacement controller from FAS. If the fryer doesn't operate properly, have the temperature probe circuit tested. Call FAS.

PROBLEM	PROBABLE CAUSES	CORRECTIVE ACTION
<p><b>CM III.5 will not go into programming mode.</b></p>	<p>A. Temporary controller malfunction caused by voltage surge.</p>	<p>A. Disconnect unit from electrical power, wait at least one minute, reconnect unit to the power supply and turn controller on.</p>
	<p>B. Failed controller.</p>	<p>B. If available, substitute controller known to be good for suspect controller (see Section 6.6). If fryer operates normally, order replacement controller from FAS.</p>
<p><b>CM III.5 displays H I as it comes out of melt cycle</b></p> <p><b>OR</b></p> <p><b>Heating mode indicator does not come on at all.</b></p>	<p>A. Setpoint incorrect.</p>	<p>A. Verify that setpoint has been properly entered.</p>
	<p>B. Temporary controller malfunction caused by voltage surge.</p>	<p>B. Disconnect unit from electrical power, wait at least one minute, and reconnect unit to the power supply.</p>
	<p>C. Failed controller.</p>	<p>C. If available, substitute controller known to be good for suspect controller (see Section 6.6). If fryer operates normally, order replacement controller from FAS.</p>
<p><b>Heating mode indicator is on but fryer is not heating properly.</b></p>	<p>A. Burner is not lit.</p>	<p>A. Refer to <i>Burner will not light</i> problem on page 6-2.</p>
	<p>B. Failed controller.</p>	<p>B. If available, substitute controller known to be good for suspect controller (see Section 6.6). If fryer operates normally, order replacement controller from FAS.</p>

### 6.3 Troubleshooting Fryers with Thermostat Controls

PROBLEM	Probable Causes	Corrective Action
<p><b>Burner does not light.</b></p>	<p>A. Pilot is not lit.</p>	<p>A. Light pilot per instructions in Chapter 3 of this manual.</p>
	<p>B. Drain valve not fully closed.</p>	<p>B. Verify drain valve is fully closed.</p>
	<p>C. No electrical power to unit. (Other than millivolt units.)</p>	<p>C. Verify that unit is correctly plugged in and that circuit breaker is not tripped.</p>
	<p>D. No gas being supplied to unit.</p>	<p>D. Verify that the gas line connections are properly connected, that any cutoff valves between the fryer and the gas main are open, and that the main gas cutoff valve is open.</p>
<p><b>Unit will not go into melt cycle or stays in melt cycle continuously.</b></p>	<p>Failed melt cycle switch. Defective melt cycle circuit board</p>	<p>Melt cycle switch or melt-cycle circuit board must be replaced. Call FAS.</p>
<p><b>Fryer never reaches frying temperature.</b></p>	<p>Failed thermostat or thermostat out of calibration.</p>	<p>Isolating the problem requires additional troubleshooting beyond the scope of operator troubleshooting. Call FAS.</p>

## 6.4 Troubleshooting the Built-In Filtration System

PROBLEM	PROBABLE CAUSES	CORRECTIVE ACTION
<p><b>Pump won't start.</b></p> <p><b>OR</b></p> <p><b>Pump stops during filtering.</b></p>	<p>A. Thermal overload switch has tripped on an overheated motor.</p> <p><i>Test:</i> If the pump stopped suddenly during the filtering process, especially if after several filtering cycles, the pump motor has probably overheated. Place the filter handle in the OFF position, allow the pump to cool for at least 45 minutes, and then press the reset button on the pump motor. Attempt to activate the pump.</p>	<p>A. If the pump runs normally after resetting the thermal overload switch, the pump was overheated.</p> <p>Always filter with the cooking oil/shortening at or near frying temperature.</p> <p>Allow the pump motor to cool off for about 10 minutes after filtering two full frypots one after the other.</p> <p>Check the filter paper after each frypot is filtered. Replace the paper if there is a large accumulation of sediment.</p>
	<p>B. Failed filter handle microswitch.</p> <p><i>Test:</i> If this is a multi-pot fryer, attempt to operate the pump using a different handle. If the pump starts, the handle microswitch is out of alignment or has failed.</p> <p>When the handle is placed in the ON position, the lever on the microswitch should be firmly pressed against the switch. If so, the switch has failed. If not, the switch is loose and/or misaligned.</p>	<p>B. If the switch is loose, tighten the screws holding it in place, ensuring that when the handle is placed in the ON position, the lever on the microswitch is pressed firmly against the switch.</p> <p>If the switch has failed, call FAS.</p>
	<p>C. Pump blockage.</p> <p><i>Test:</i> Close the drain valve. Place the filter handle in the OFF position, allow the pump to cool for at least 45 minutes, and then press the reset button on the pump motor. Pull the filter pan from the unit and then activate the pump. If the pump motor hums and then stops, the pump is blocked.</p>	<p>C. Pump blockages are usually caused by sediment build-up in the pump due to improperly sized or installed filter paper and failure to use the crumb screen. Call FAS to have blockage cleared.</p> <p>Ensure that filter paper is of the proper size and is installed properly, and that the crumb screen is used.</p>

PROBLEM	PROBABLE CAUSES	CORRECTIVE ACTION
<p><b>Pump starts, but no transfer takes place or the transfer is very slow.</b></p>	<p>A. Cooking oil/shortening is too cold for filtering.</p>	<p>A. To properly filter, the oil or shortening should be at or near 350°F (177°C). At temperatures lower than this, the oil or shortening becomes too thick to pass through the filter medium easily, resulting in much slower oil return and eventual overheating of the filter pump motor. Ensure that the cooking oil or shortening is at or near frying temperature before draining into filter pan.</p>
	<p>B. Improperly installed or prepared filter pan components.</p> <p><i>Test:</i> Close the drain valve. Move the filter handle to the OFF position, pull the filter pan (and Power Shower, if so equipped) from the unit. Move the filter handle to the ON position.</p> <p>If a strong stream of air is being pumped out of the oil return port (or the Power Shower port), the problem is with the filter pan components.</p>	<p>B. Remove the oil from the filter pan and replace the filter paper, ensuring that the filter paper support screen is in place <i>under</i> the paper.</p> <p>If this does not correct the problem, the filter pan suction tube is probably blocked. Remove the blockage using a thin, flexible wire. If unable to remove the blockage, call FAS.</p>
	<p>C. Improperly installed or prepared filter pan components (cont.).</p>	<p>C. Verify that filter connection O-rings are present and in good condition.</p> <p>Replace the filter paper, ensuring that the filter paper support screen is properly positioned <i>under</i> the paper.</p>



<b>PROBLEM</b>	<b>PROBABLE CAUSES</b>	<b>CORRECTIVE ACTION</b>
<b>Power Shower is not spraying properly.</b>	A. Plugged openings or solidified shortening in the Power Shower.  <i>Test:</i> Look for oil or shortening squirting out around the Power Shower gasket. If so, Power Shower is obstructed.	A. Clean the Power Shower per instructions in Chapter 5 of this manual.
	B. Missing/worn O-rings and gasket on Power Shower.	B. Verify that O-rings and gasket are present and in good condition.
	C. Missing paper in filter pan. (This causes too much pressure in the oil return lines, resulting in a strong flow through the Power Shower, but also squirting of oil from around the gasket.)	C. Verify that filter paper is properly installed in the filter pan.

### 6.5 Troubleshooting Abnormal Burner Operation

<b>PROBLEM</b>	<b>PROBABLE CAUSES</b>	<b>CORRECTIVE ACTION</b>
<b>Fryer is operating normally, but flames are rolling out of the front of the burner.</b>	Obstructed gas valve vent tube.	Shut the fryer down and clean the gas valve vent tube in accordance the instructions on Page 5-4 – 5-5 of this manual.
	Obstruction or carbon build-up in the flue.	Shut the fryer down and remove any obstructions and/or accumulations of carbon in the flue.



Shipping Address: 8700 Line Avenue, Shreveport, Louisiana 71106

TEL 1-318-865-1711 FAX (Parts) 1-318-219-7140 FAX (Tech Support) 1-318-219-7135

PRINTED IN THE UNITED STATES

SERVICE HOTLINE  
1-800-551-8633

819-6042A  
OCTOBER 2011