

# Operation Manual

# Product Holding Bin DHB2PT-33 Series

## Product Identification

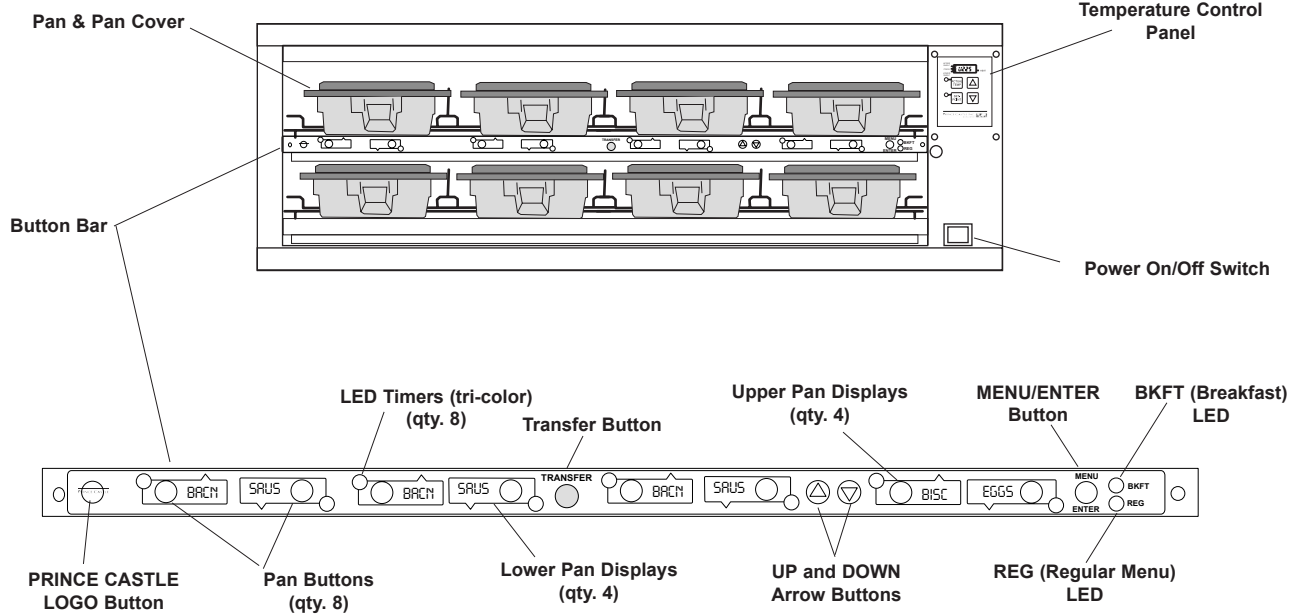

### LIMITED WARRANTY

This product is warranted to be free from defects in material and/or workmanship for a period of 1 year from date of original installation, not to exceed 18 months from the date of manufacture.

Any component which proves to be faulty in material and/or workmanship will be replaced or repaired (at the option of Prince Castle, Inc.) without cost to the customer for parts and labor. This warranty covers on-location service (i.e. trip charges and/or mileage). Travel mileage is limited to 100 miles (200 Kilometers) round trip (one trip warranty) from an authorized service agency or its sub-service agency.

This warranty is subject to the following exceptions/conditions:

- Use of any non-genuine Prince Castle parts voids this warranty.
- All labor to be performed during regular work hours. Overtime premium (the incremental amount) will be charged to the customer.
- Damage caused by carelessness, neglect and/or abuse (e.g., dropping, tampering or altering parts, equipment damaged in shipment, by fire, flood or an act of God) is not covered under this warranty.
- All problems due to operation at voltages other than that specified on equipment nameplates are not covered by this warranty. Conversion to correct voltage is the customer's responsibility.
- This equipment must be serviced by Prince Castle Authorized Service Agency or a Prince Castle Service Technician during the warranty period.

### TABLE OF CONTENTS

Product Identification .....	1
Safety Information .....	2
Installation .....	2
Operation .....	3
Cleaning .....	4
Programming .....	4-9
CastleNet Communications Network .....	10
Factory Presets .....	11
Troubleshooting .....	12
Wiring Diagram .....	12
Parts List & Exploded View .....	13



**PRINCE CASTLE INC.**   
WORLDWIDE

355 East Kehoe Blvd. • Carol Stream, IL 60188  
Phone: 630-462-8800 • Toll Free: 1-800-PCASTLE  
Fax: 630-462-1460 • www.princecastle.com

## Safety Information

### ⚠ WARNING

Indicates information important to the proper operation of the unit. Failure to observe may result in damage to the equipment and/or severe bodily injury or death.

### ⚠ CAUTION

Indicates information important to the operation of the unit. Failure to observe may result in damage to the equipment.

## Electrical Information

Model	Volts	Hz	Watts	Amps	Plug Number	Agency Approval
DHB2PT-33	208-240	60	2600 Max	10.8 Max	NEMA L6-15P	UL / cUL / UL Sanitation
DHB2PT-33CE	220-240	50	2600 Max	10.8 Max	CEE 7-7 Schuko	CE / UL Sanitation
DHBPT-33GB	240	50	2600	10.8	BS-1363A	CE / UL Sanitation
DHBPT-33AU	240	50	2600	10.8	BS-3112	UL Sanitation
DHBPT-33F	220-240	50	2600 Max	10.8 Max	None	UL Sanitation
DHBPT-33J	200	50/60	1750	8.7	None	UL Sanitation

## Installation

A. Remove the unit from the carton and inspect for signs of damage. If there is damage to the unit:

- notify the carrier within 24 hours of delivery
- save carton and packaging materials for inspection purposes
- contact your local dealer, or if purchased directly, the Prince Castle Sales Department at 800-722-7853 or 1-630-462-8800 to arrange for a replacement unit.

**NOTE:** When installing this unit, the ambient temperature at the mounting site should not exceed 100°F.

- B. Place the bin on a counter and seal the base to the counter with food-approved sealant.
- C. Plug the power cord into the bin and connect the plug into the proper electrical outlet (15 amp, 120 Volt). All connections must be in accordance with local electrical codes and any other applicable codes.

**NOTE:** The electrical receptacle should be a dedicated outlet. No other equipment should be operating on the line (refrigerators, fryers, etc.).

- D. Install the racks, pans and pan covers into the cavities.
- E. Turn the power switch to ON. Allow 30 minutes for warm-up.

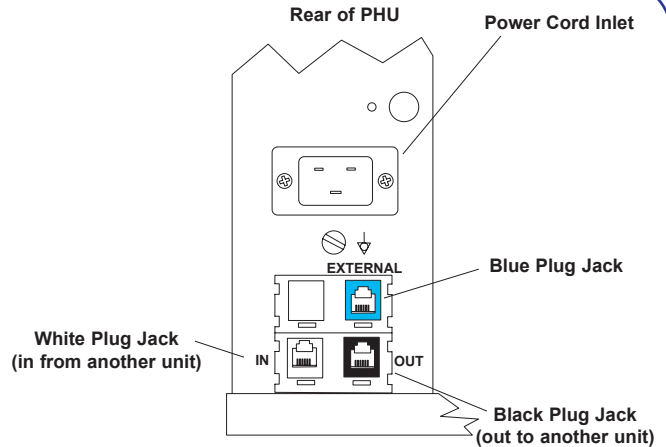

**NOTE:** If the unit is to be networked with other Prince Castle units, a Retro Bun Timer may be connected to any one bin in the chain. Refer to CASTLENET COMMUNICATIONS NETWORK in this manual.

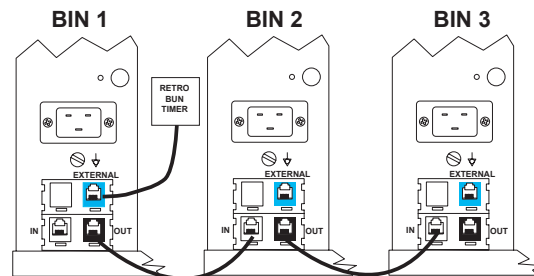

Prince Castle reserves the right to change specifications and product design without notice. Such revisions do not entitle the buyer to corresponding changes, improvements, additions or replacements for previously purchased equipment.

## Operation

- 1** Turn power On/Off switch to ON position.  
Load pan covers (if used) onto pan racks and insert racks into the unit.

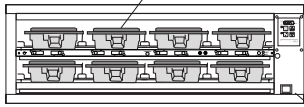

Allow 30 minutes for heaters to reach operating temperature. The Temperature Display will show temperature as unit warms up to the operating temperature.

Power On/Off Switch

- 2** Press all PAN Buttons



The PAN DISPLAYS will show the assigned product name.

If no product is assigned, the display will be dim and show "----". Pressing the PAN button will not activate the timer if "----" is displayed. Pressing PAN button when product name is displayed will start timing cycle.

BKFT (Breakfast) or REG (Regular Menu) will be lit depending on pre-programmed menu.

- 3** LED Timing Status



### LED Timers

RED (steady)	=	Ready for product
RED (flashing)	=	Discard product
GREEN (steady)	=	Oldest product, use first
GREEN (flashing)	=	Cook more product
YELLOW (steady)	=	Newer product, use green first
YELLOW (flashing)	=	Cook more product

- 4** When LED is steady RED, load product and press the PAN Button.

If no other pan is active for a product, the LED for the first pan loaded will turn from RED to GREEN.

The LED for the 2nd pan (3rd pan, etc.) loaded will turn from RED to YELLOW.

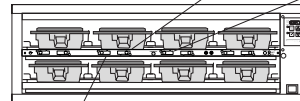

An LED timer can be stopped (cancelled) at any time by pressing and releasing the corresponding PAN Button.

If only one pan is active for a product, the LED will turn from RED to GREEN.

- 5** When any of the timer LED's flash, cook more product or remove and discard product as indicated.

**GREEN** Flashing  
Cook more product

**YELLOW** Flashing  
Cook more product

**RED** Flashing  
Discard product

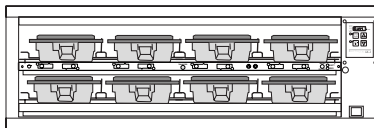

**WARNING**  
Hot surfaces.

- 6** Product, along with any remaining time, can be transferred from one cavity to another as follows:

A. Press and release the TRANSFER Button. Displays for available bins are brightly lit. Displays for bins currently timing, are dimly lit.

C. Press and release the TRANSFER button again.

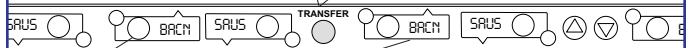

B. Press and release the PAN button of the product to be moved.

D. Move the product. Press and release the PAN Button for the new location. The new location will finish timing the product. When the transferred pan timing expires, location will revert to original menu setting.

NOTE: If product transfer is not completed within a pre-programmed transfer time, the transfer will be cancelled. See your Manager.

## Operation (continued)

**7** To change a menu selection for a specific pan cavity, use the following steps:

**A.** Press and hold the Prince Castle Logo Button for 6 seconds. All Pan Displays will show "PROG". All LED Timers will be red.

**D.** Press the UP or DOWN Button to scroll to the desired menu item.

**E.** Press the MENU/ENTER button to select the menu item.



**B.** Press and hold the MENU/ENTER Button. The display next to the MENU/ENTER Button will display the menu choices. While holding the MENU/ENTER button, press the UP or DOWN Buttons to scroll through the menu choices.

**F.** Repeat steps A - E as required for other Pan Displays. Press the Prince Castle Logo Button to exit the program mode.

**C.** Press a PAN Button to change the menu. The LED Timer will change to yellow and the Display will change from "PROG" to the assigned menu item.

**NOTE:** Up to six products may be programmed for each Pan Button (1 for each menu). In addition, a pan may be set as "not used" by assigning "----" as its product.

**8** To shut down the unit, turn the power On/Off switch to OFF.

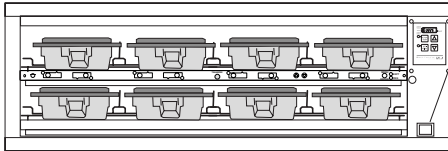

## Cleaning

### ⚠ WARNING

Before performing any maintenance, turn the power switch to the OFF position and unplug the power cord from the electrical receptacle.

### ⚠ CAUTION

This unit is not watertight. Do not clean with a water jet/jet spray. Do not immerse the unit in water.

1. Turn the unit off and unplug the power cord from the electrical receptacle.
2. Remove the pan covers and pan racks. Wipe all parts and unit with a damp cloth. **DO NOT** use a green scotch bright pad cleaner, ice or water.

## Setting Temperature

**1** The unit has four shelves, each with an upper and lower heater (eight heaters total).

The factory pre-set for the upper heaters is 225°F.

The factory pre-set for the lower heaters is 195°F.

Each upper heater has a programmable range of 150° - 275°F.

Each lower heater has a programmable range of 150° - 225°F.

Use the control below and the following steps to set the setpoint temperatures for each heater.

### UPPER SHELF LED

This LED will be lit to indicate upper shelf is selected

### PROG LED

This LED will be lit to indicate unit is in Program Mode

### LOWER SHELF & LED

This LED will be lit to indicate lower shelf is selected

### ACTUAL TEMP BUTTON & LED

Press to display actual temperature for the selected heater. LED will be lit when actual temperature is displayed.

### SETPOINT BUTTON & LED

Press to display setpoint temperature of a selected heater. LED will be lit when setpoint temperature is displayed.

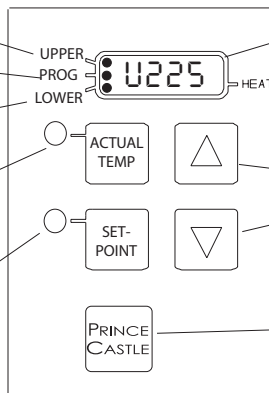

### TEMPERATURE DISPLAY

**NOTE:** The unit is preset to display temperature in Fahrenheit. To display in Celsius, press and hold the DOWN Arrow button immediately after turning on the power switch. To switch back to Fahrenheit, press and hold the UP Arrow button after turning on the power switch.

### UP/DOWN ARROW BUTTONS

Used with other buttons to scroll through heater and temperature selections

### PRINCE CASTLE LOGO BUTTON

Press to enter temperature selections

**NOTE:** To reset all times and temperatures to the factory settings, turn the unit off, then press and hold the UP and DOWN arrow buttons simultaneously while turning the unit back on. A "P" will appear in the display and all times and temperatures will be reset to original factory settings.

## Setting Temperature (continued)

- 2** Press the UP or DOWN Arrow Buttons until the desired shelf LED and upper (U) or lower (L) heater is selected.

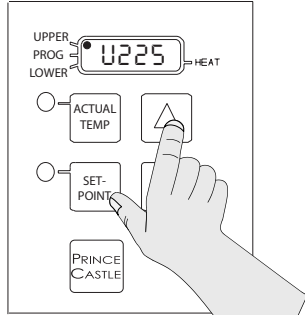

- 3** Press and hold the SETPOINT Button and the Prince Castle Logo Button for 5 seconds. The Program LED will light.

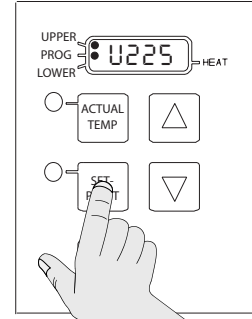

- 4** Press the UP or DOWN Arrow Buttons until the desired setpoint temperature is displayed

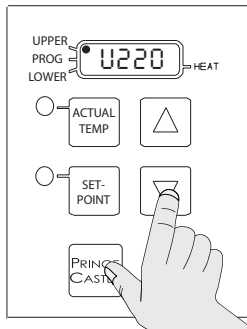

- 5** Press the Prince Castle Logo Button to save the new setpoint value. Repeat steps 2–5 to change the setpoint for any other heater.

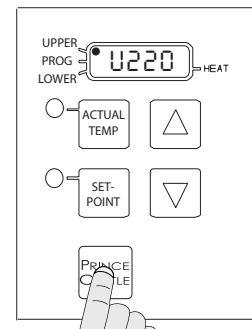

## Calibrating Heaters

**1**

Use the following steps to calibrate the individual heaters.

**NOTE:** Allow sufficient amount of time for temperatures to stabilize before starting calibration.

Press the UP or DOWN Arrow Buttons until the desired shelf LED and upper (U) or lower (L) heater is selected.

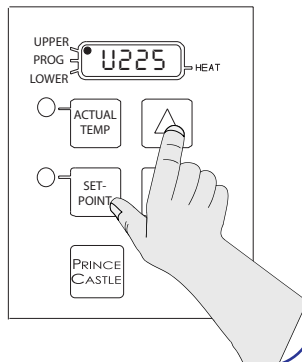

**2**

Take a temperature reading within the shelf near the center of the heater surface.  
Use a standalone temperature meter (not supplied).

**⚠ WARNING**  
Hot surfaces. Use caution when taking temperature readings within the shelf

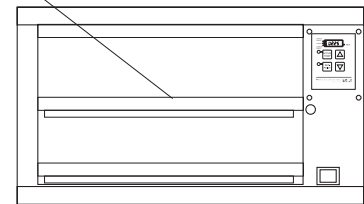

**3**

Press and hold the PRINCE CASTLE LOGO and ACTUAL Buttons for 5 seconds. The semi-colon (;) LED indicator will light. The temp displayed is the actual heater temperature sensed by the controller.

To clear any offset readings, press the SETPOINT Button.

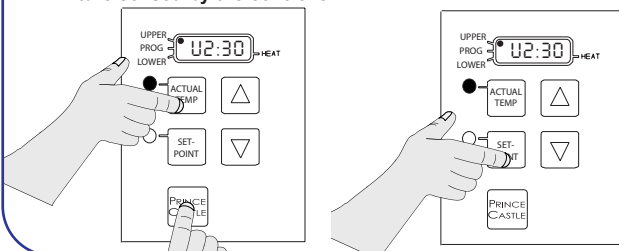

**4**

Press the UP or DOWN Arrow Buttons until the temperature displayed matches the reading obtained in Step 2.

Press the PRINCE CASTLE LOGO Button to save the temperature value and exit the Calibration Mode.

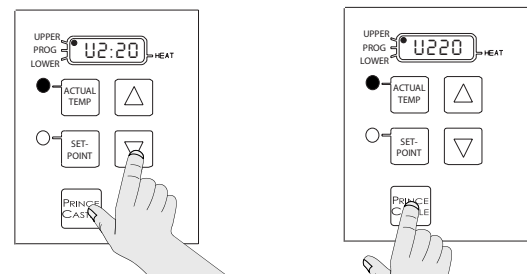

## Selecting Breakfast and Regular Menus

- 1** There are six menus available:  
BKFT LED ON = Menu1 or Menu6  
REG LED ON = Regular2, Regular3, Regular4, or Regular5
- Press and hold the MENU/ENTER button, then use the UP or DOWN Arrow button to scroll through the 6 menus.

*When scrolling, menu numbers appears in this display.*



- 2** When the desired menu is displayed, release the MENU/ENTER button. The food products for the menu will be displayed in the upper and lower BUN TRAY displays.

*When timers for a different menu are still active, those BKFT or REG LED's will flash until they are all cancelled.*



## Programming the Menus

- 1** Press and hold the PRINCE CASTLE LOGO button (on the button bar) until all the displays show PROG and the BUN TRAY buttons LED's all glow red.

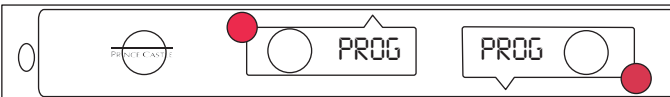

- 2** Press and hold the MENU/ENTER button, the display next to the MENU/ENTER button will show the menu choices. Use the UP or DOWN Arrow button to scroll through the 6 menus. Release the MENU/ENTER button when the desired menu is displayed.

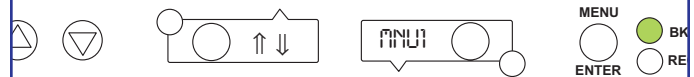

*When the MENU/ENTER button is released, all displays will again show PROG.*



- 3** A. Press the PAN button next to the display to be changed. The LED will change from red to yellow and the display will change from PROG to the assigned menu item.



- B. Press the UP or DOWN Arrow buttons to scroll to the desired menu item.  
C. Press the MENU/ENTER button to save the selection. All displays will show PROG.



- 4** A. Repeat Steps 2 & 3 as required.  
B. Press the PRINCE CASTLE LOGO button to exit the Programming Mode and return to the Run Mode.

*NOTE: Up to six items (one for each menu) may be programmed for each tray button. A tray may be set as "not used" by assigning "----" as its product.*

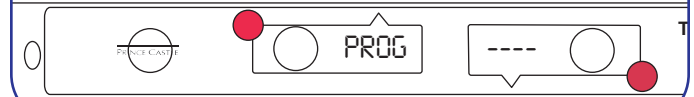

## Changing the Hold & Cook-More Times

- 1** A. The SET PRODUCT TIME menu is used to change the Hold & Cook-More times.
- B. Press and hold the PRINCE CASTLE LOGO button, then immediately press and hold the MENU/ENTER button until the display shows one of three programming menus.
- C. Use the UP or DOWN Arrow button to scroll to the SET PROD TIME ↑↓ ENTR menu.

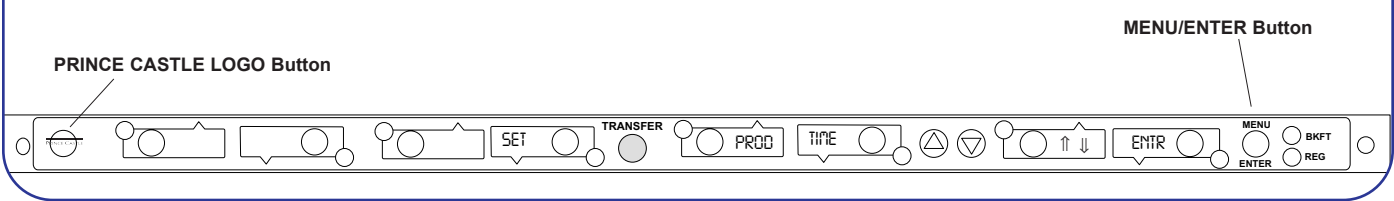

- 2** A. Press and release the MENU/ENTER button to enter the Set Product Time menu. The display will show, for example, SET EGGS TIME ↑↓ ENTR.
- B. Use the UP or DOWN Arrow button to scroll through the list of products. When the desired product is displayed, press the MENU/ENTER button to select it.

*Refer to the Product Menu Details on page 8 for a list of products and their corresponding display names.*

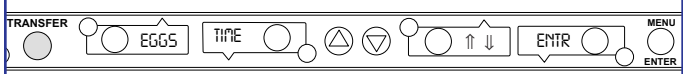

**NOTE:** Holding the UP or DOWN Arrow Buttons for longer than 2 seconds will cause the product list to automatically scroll up or down.

- 3** A. The display now shows the current hold time.
- B. Use the UP or DOWN Arrow button to scroll to the desired hold time. When the desired hold time is displayed, press the MENU/ENTER button to save the desired hold time.

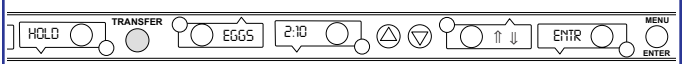
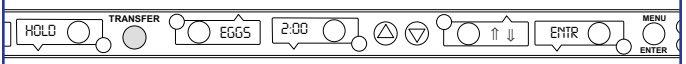

**NOTE:** Hold time cannot be reduced to less than the Cook-More time plus one minute.

- 4** A. The display will now show current Cook-More time. Use the UP or DOWN Arrow button to scroll to the desired cook - more time.

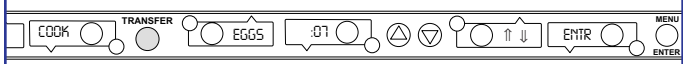

- B. When the desired cook-more time is displayed, press the MENU/ENTER Button to save it.

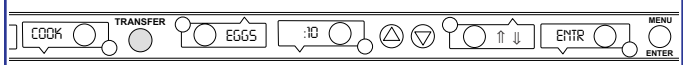

**NOTE:** Cook-More time cannot be increased to more than the Hold time minus one minute.

- 5** A. The display will show SET PROD TIME ↑↓ ENTR. Repeat Steps 2 – 4 for any other product.
- B. Press and release the PRINCE CASTLE LOGO button at any time to exit the Programming Mode and return to the Run Mode.

**NOTE:** If the MENU/ENTER button has not been pressed to save any changes, the program will revert to the original values.

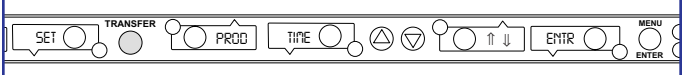

## Changing Product Names

- 1
  - A. The EDIT PRODUCT NAME menu is used to change a default product name to one of your own choosing.
  - B. Press and hold the PRINCE CASTLE LOGO button, then immediately press and hold the MENU/ENTER button until the display shows one of four programming menus.
  - C. Use the UP or DOWN Arrow button to scroll to the EDIT PROD NAME ↑↓ ENTR Menu.

**NOTE:** The default names available for editing are listed on page 8.

PRINCE CASTLE LOGO Button

MENU/ENTER Button



- 2
  - A. Press and release the MENU/ENTER button to enter the Edit Product Name menu. The display will read SEL. PRG XXXX ↑↓.
  - B. Use the UP or DOWN Arrow button to scroll through the list of products.
  - C. When the desired product is displayed, press the MENU/ENTER button to select it. The first letter (in this case, the E) will start blinking.



- 3
  - A. To change the blinking E, use the UP or DOWN Arrow button to scroll to the desired letter/number/symbol.
  - B. When the desired selection is displayed, press the PAN button (to the left or right of the selected display) to move to the next digit.
  - C. Repeat for all digits.



**NOTE:** Holding the UP or DOWN Arrow Buttons for longer than 2 seconds will cause the selected digit to automatically scroll up or down.

- 4
  - A. When all four digits have been changed, press the MENU/ENTER button to save the new name.

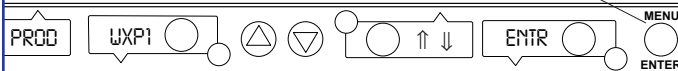

- 5
  - A. The display will show EDIT PROD NAME ↑↓. Repeat Steps 2-4 for any other product.
  - B. Press and release the PRINCE CASTLE LOGO button at any time to exit the Programming Mode and return to the Run Mode.

**NOTE:** If the MENU/ENTER button has not been pressed to save any changes, the program will revert to the original names.







## CastleNet® Communications Network

The Prince Castle DHB-BK Bins and Retro Bun Timer and New Bun Cabinet Timers can be inter-connected to form the CastleNet® Communication Network. The network can be used for data transfer between bins and timers for menu updates or to transfer product hold time from bin-to-bin. A PDA (or similar device) or a notebook with Prince Castle MenuView® software is used to connect to the network and enter the desired changes.

Each bin is supplied with a standard 25' cable and allows units to be "daisy-chained" together to form the network. If cable is too short, use Prince Castle Extender Cable Kit, P/N PC-COMEXT.

The factory default address for Main bins and timers is address 1.  
The factory default address for Specialty bins and timers is address 2.  
If a third bin is used, the address must be set at 3.  
The factory default address for the Retro Bun Timer is 80MF.

**1** Telephone jack plugs are located on the back of the unit. Connect the units using the cables provided as shown here.

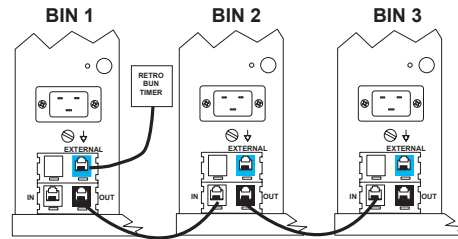

Example

**2** **IMPORTANT:** Each timer must have a different address. If a location has three bins, it is recommended that the bins and timers be set consecutively to addresses 1 through 3.

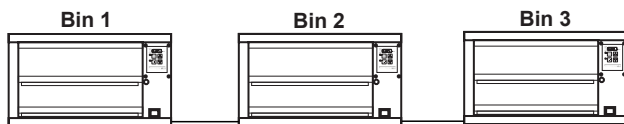

Example

**4** Use the UP or DOWN Arrow buttons to scroll to the desired address. Press the PRINCE CASTLE LOGO Button to store the new address.

**Available addresses are:**  
BIN1 thru BIN9, BINA, BINB, BIN C, BIND, BIN E and BIN F.

**IMPORTANT:** Continue to step 5 to check the timer address. **No two timers can have the same address.**

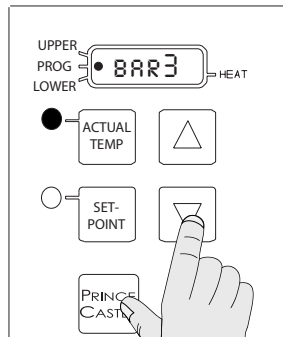

**3** **A.** Turn the power switch off, wait 15 seconds. Turn the switch to ON while pressing and holding the ACTUAL and SET-POINT buttons. The display will show the current bin address.

**B.** Continue to hold the buttons until PROG LED turns on.

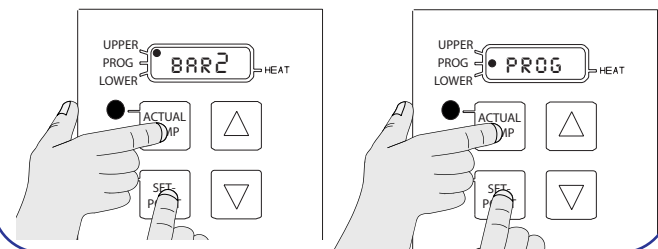

**5** To check the timer address, press and hold the PRINCE CASTLE LOGO button and the DOWN Arrow button. The current timer address will be displayed in the far right timer display.

To change the timer address, proceed to step 6.

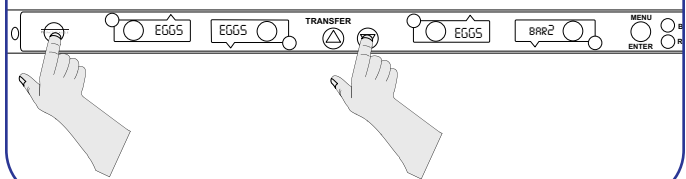

**6** To change the timer address, turn the unit power switch off and wait 15 seconds. Turn the power switch back on and immediately press and hold the PRINCE CASTLE LOGO button and the DOWN Arrow button for approximately 6 seconds or until the display shows SET ADDR ↑ ↓ 8AR2.

The address number will blink on/off.

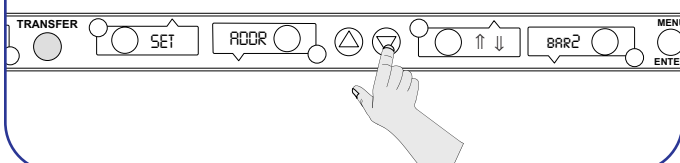

**7** Use the UP or DOWN Arrow button to scroll to the desired address. Press the MENU/ENTER button to store the new address and return to normal operating mode.

**Available addresses are:**  
BIN1 thru BIN 9, BIN A, BIN B, BIN C, BIN D, BIN E and BIN F.

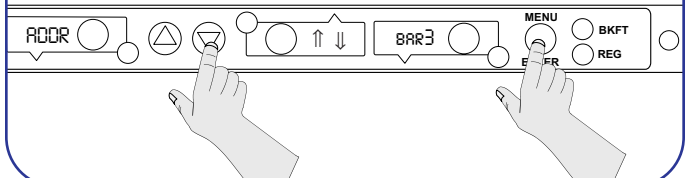

## Factory Presets

### PRODUCT MENU DETAILS

Product	Display Name	Hold Minutes <sup>1</sup>	Cook-More Minutes <sup>1</sup>
Burger	BUR1	30	3
Burger	BUR2	30	3
Chicken Patty	CHX1	30	3
Chicken Patty	CHX2	30	3
Chicken Patty	CHX3	30	3
Chicken Wing	WING	30	3
Fish	FISH	5	3
Eggs	EGGS	30	3
Sausage	SAUS	30	3
Bacon	BACN	30	3
Ham	HAM	30	3
Popper	POP	30	3
Mozzarella Stick	MOZ	30	3
Onion	ONIN	10	7
Mushroom	MUSH	30	3
Chicken Nuggets	NUGG	30	3
Spicy Chicken	SPCY	30	26
French Toast	TOST	10	8
Chicken Stars	STAR	30	27
Large	LRG	20	17
\$6 Burger	SIX	20	17
BBQ Chicken	BBQ	20	17
Crispy Chicken	CRSP	30	26
Special #1	SPC1	30	3
Special #2	SPC2	30	3

1. Hold and Cook-More times may be re-programmed. See page 7.

2. Product abbreviations SPC1 thru SPC9 may be reprogrammed. See page 8.

### Menus

UP	DOWN	UP	DOWN	UP	DOWN	UP	DOWN	Menu	LED
CRSP	ONIN	BBQ	SPCY	SIX	SIX	LRG	LRG	MNU1	Bkft
BUR1	BUR1	BUR1	BUR1	BUR2	BUR2	BUR2	BUR2	MNU2	Reg
CHX1	CHX1	CHX2	CHX2	CHX3	CHX3	WING	FISH	MNU3	Reg
CHX1	CHX2	WING	WING	MOZ	MOZ	POP	POP	MNU4	Reg
CHX1	CHX2	CHX3	WING	WING	POP	ONIN	MUSH	MNU5	Reg
EGGS	EGGS	EGGS	EGGS	HAM	BACN	SAUS	SAUS	MNU6	Bkft

## Troubleshooting

PROBLEM	POSSIBLE CAUSE	CORRECTIVE ACTION
Display flashes $\square$ PN & REL.	Open relay. Circuit inoperable.	Replace power circuit board.
Display flashes SHr & REL.	Shorted relay. Circuit inoperable.  Open heater.  Unplugged ribbon cable between power and main circuit boards.	Replace power circuit board.  Test heater resistance (150.2 Ohms). Replace heater if necessary.  Verify ribbon cable connection.
Display flashes $\square$ PN & REL.	Temperature is below 75°F.  Heater inoperable.  Probe inoperable.  Relay inoperable.	Normal display during warmup.  Test heater resistance (150.2 Ohms).  Check for open thermocouple wires from probe. Replace heater/probe assembly.  Replace power circuit board.
Display shows HHH for an extended period of time and heater surface temperature is hot.	Temperature is above 300°F (abnormal operation).	Diagnostic circuit inoperable. Replace power circuit board.
Display shows HHH for an extended period of time and heater surface temperature is cool.	Probe is inoperable.	Check for pinched thermocouple wires from probe. Replace heater/probe assembly.

## Wiring Diagram

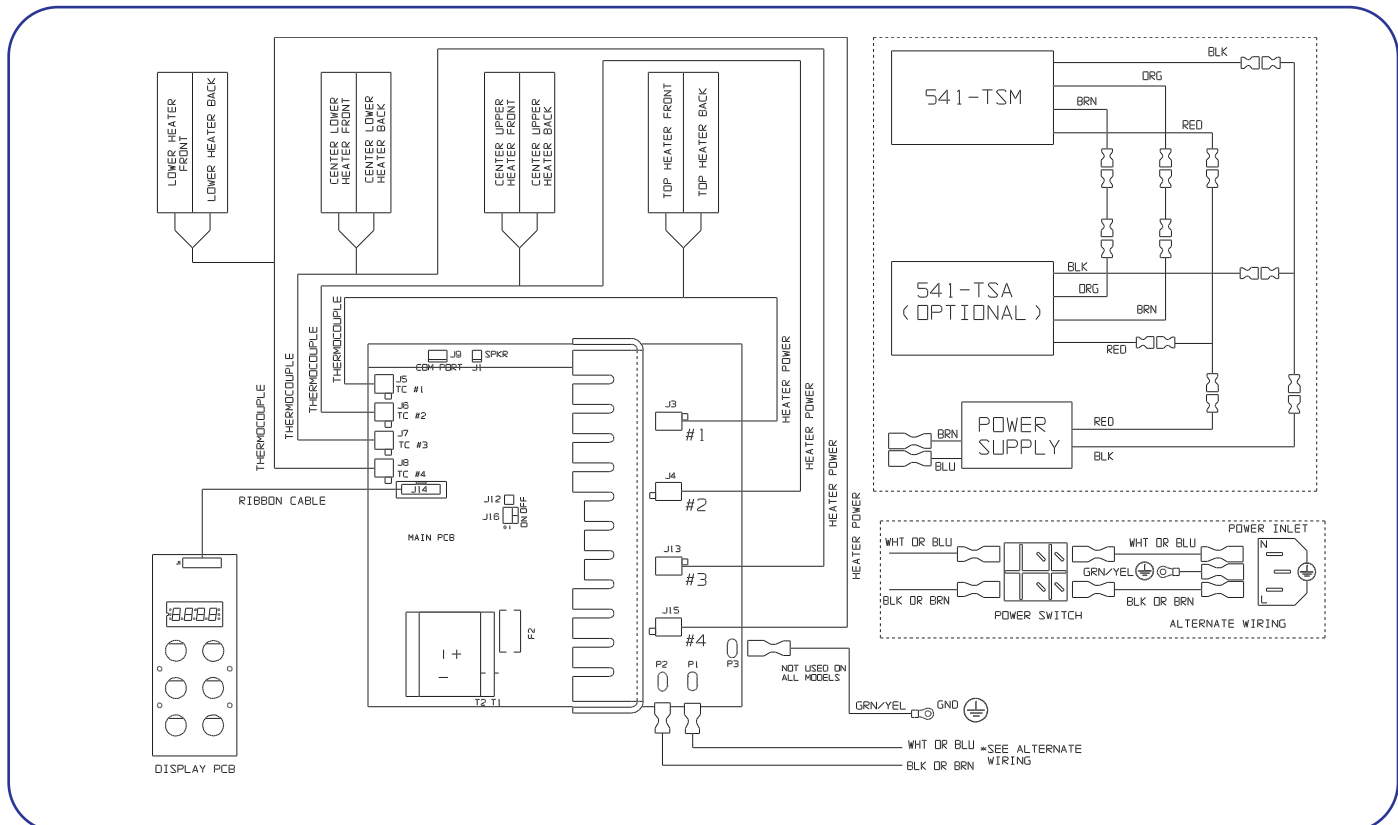

Parts List & Exploded View

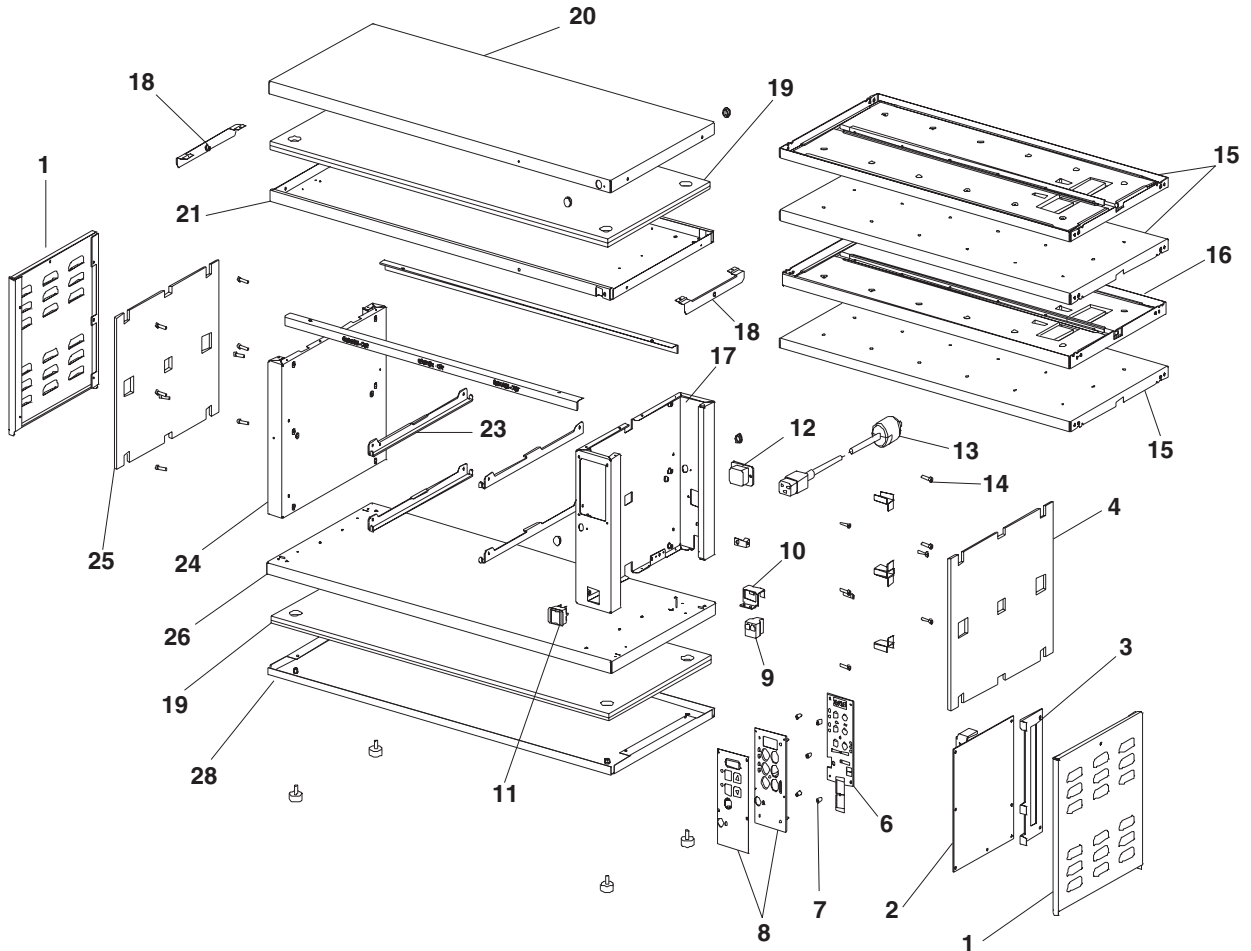

Ref.	Part No.	Description	Ref.	Part No.	Description
1	541-316	Side Panel	19	541-369	Insulation
2	541-389S	Main P. C. Board Kit	20	541-329	Top Cover
3	541-318	P.C. Board Bracket	21	541-324	Header
4	541-317	Right Side Insulation	22	541-650	Trim
5	541-326	Wire Chase	23	541-383	Shelf Bracket
6	541-333S	Display P.C. Board Kit	24	541-488	Chassis, Left
7	89-955	Spacer	25	541-317	Insulation
8	541-353S	Overlay and Bracket Kit	26	541-606	Base
9	86-118	Modular Coupling	27	197-232	Foot
10	541-320	Hold Down Bracket	28	541-323	Bottom Cover
11	78-184S	Power Switch	*	541-479	Black Pan Covers (Not Shown)
12	88-609	Power Inlet	*	PC-COMEXT	Cable, Prince Castle (Not Shown)
13	72-200-25S	Power Cord Kit	*	TBD	Cable, K-Mart (Not Shown)
14	76-724	Screw, Socket, 8-32 x 3/4	*	TBD	Cable, Target (Not Shown)
15	541-359S	Lower Heater Assy (230 Volt)	*	TBD	Cable, Wal-Mart (Not Shown)
16	541-376S	Upper Heater Assy (230 Volt)	*	940-0504	Cable, Radio Shack (Not Shown)
17	541-489	Chassis, Right		279-423	
18	541-129	Side Cover Bracket			





