

SOLID STATE DIGITAL ENERGY SAVING TOASTER
PRINCE CASTLE MODEL NO. 411-SDPA

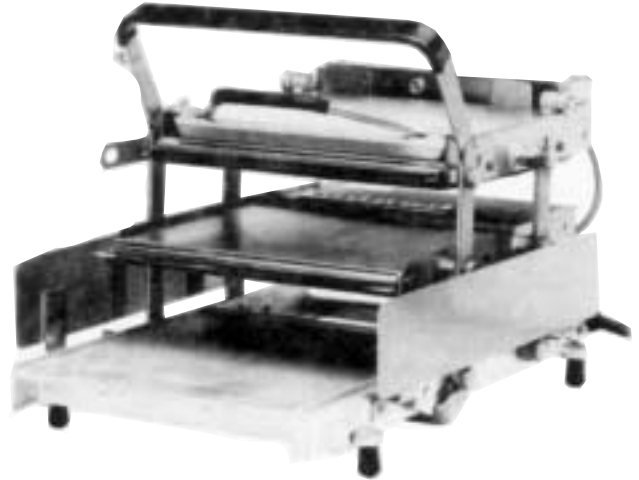

This equipment chapter is to be placed in the
toasters section of your *Equipment Manual*.

**MANUFACTURED FOR
MCDONALD'S®
BY
PRINCE CASTLE INC.
355 KEHOE BLVD.
CAROL STREAM, IL. 60188 USA
PHONE 1-630-462-8800
TOLL FREE NUMBER
1-800-323-2930
FAX:1-630-462-1460**



WARRANTY	Page 1
SIDE VIEW	Page 2
FRONT VIEW	Page 3
REAR VIEW	Page 3
INTERNAL VIEW	Page 4
EQUIPMENT SET-UP	Page 5
PROGRAMMING	Page 6
CLEANING	Page 8
TROUBLESHOOTING	Page 8
WIRING DIAGRAM	Page 9

LIMITED WARRANTY

This product is warranted to be free from defects in material and/or workmanship for a period of (1) year from date of original installation not to exceed 18 months from date of shipment from our factory. Any part or component which proves to be faulty in material and/or workmanship within the warranty period will be replaced or repaired without cost to the customer for parts or labor. (At the option of Prince Castle.)

This warranty is subject to the following exceptions/conditions:

- Any use of Non-genuine Prince Castle spare parts voids this warranty, and all work must be performed by an authorized Prince Castle Service Agent.
- All labor should be performed during regular working hours. Overtime premium will not be covered.
- Travel charges are limited to 100 miles (200 km) round trip, 2 hours travel time, one trip per repair.
- Damage caused by carelessness, neglect, and/or abuse (e.g., using wrong current, dropping, tampering with or altering electrical components, or improper cleaning) is not covered.
- Equipment damaged in shipment, by fire, flood or an act of God.

This manual is for the exclusive use of licensees and employees of McDonald's Systems, Inc.

SIDE VIEW

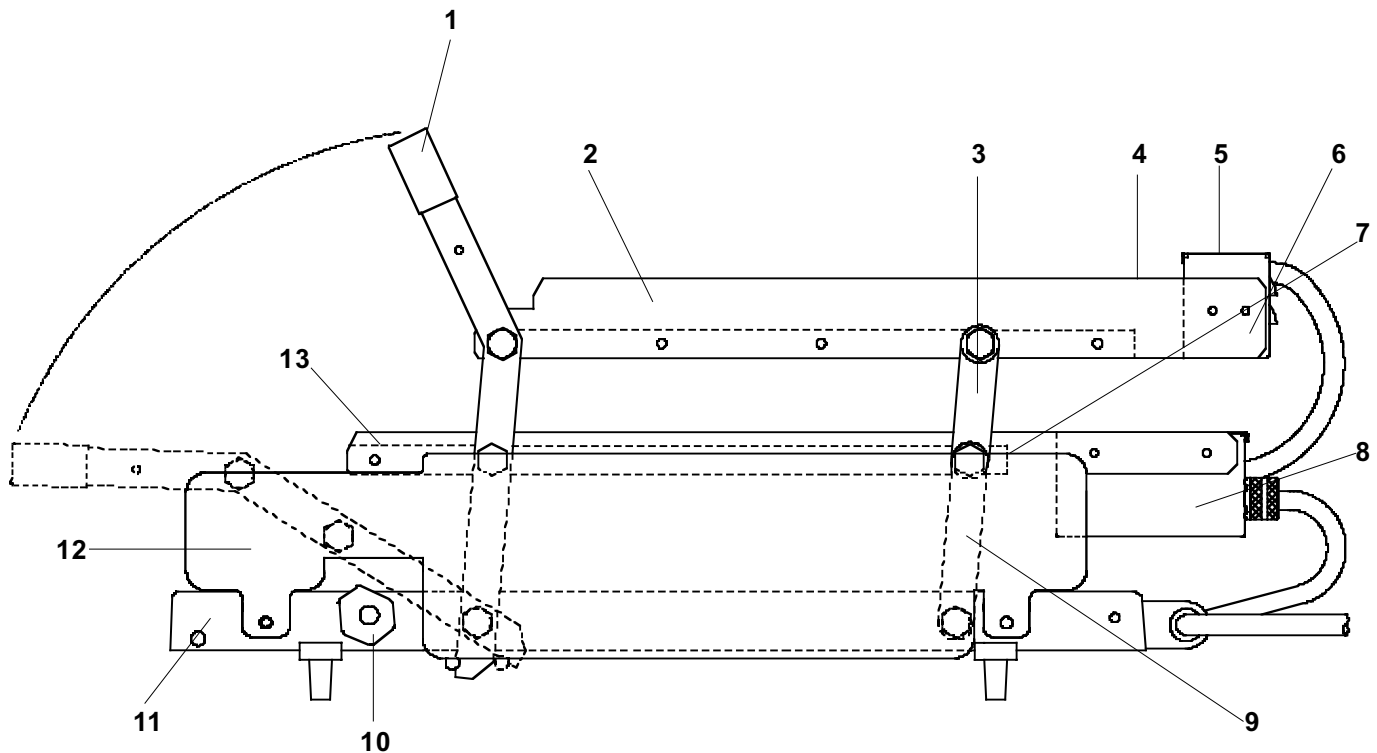

PARTS LIST

ITEM	PART NUMBER	DESCRIPTION
1	411-784S	Handle and Lever Assy.
2	248-110	Right or Left Hand Upper Bun Fence
3	411-785S	Upper Rear Lever Assy.
4	248-110	Upper Rear Bun Fence
5	411-712	Upper Cover
6	411-763	Upper Chassis
7	248-110	Lower Rear Bun Fence
8	411-787	Lower Chassis
9	411-459S	Lower Rear Lever Assy.
10	411-137	Right Hand Stop Block
	411-138	Left Hand Stop Block
11	411-2S	Base
12	411-728	Side Panel, Right or Left Hand
13	411-768	Right Hand Lower Bun Fence
	411-769	Left Hand Lower Bun Fence
Not Shown	411-114	Safety Latch
Not Shown	411-744	Bun Board

FRONT VIEW

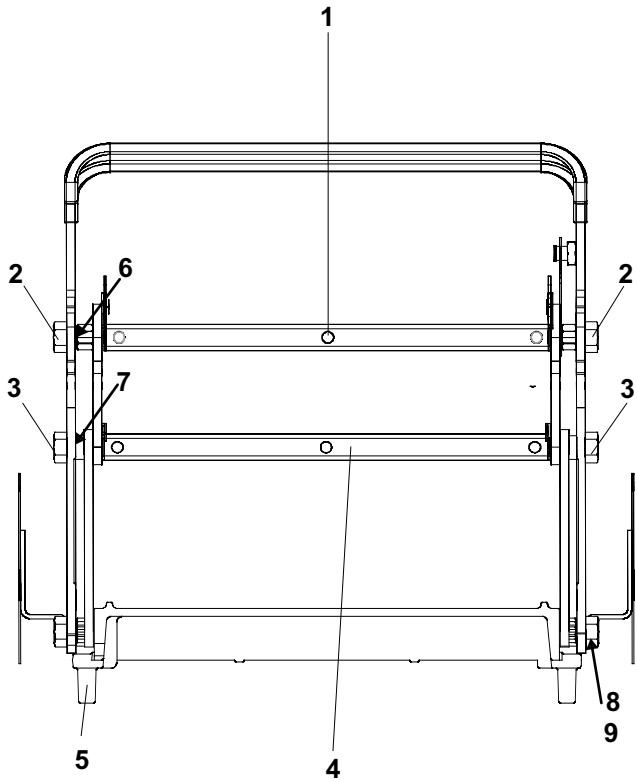

PARTS LIST

ITEM	PART NUMBER	DESCRIPTION
1	411-483S 411-6S	Upper Platen 230V Upper Platen 120V
2	411-60	Front Upper Platen Stud
3	411-60	Front Lower Platen Stud
4	411-486S 411-8S	Lower Platen 230V Lower Platen 120V
5	89-959S	Foot (Pkg. of 4)
6	411-770	Front Upper Spacer
7	411-57	Front Lower Spacer
8	411-347	Base Stud Front & Rear
9	411-113	Base Spacer Front & Rear

REAR VIEW

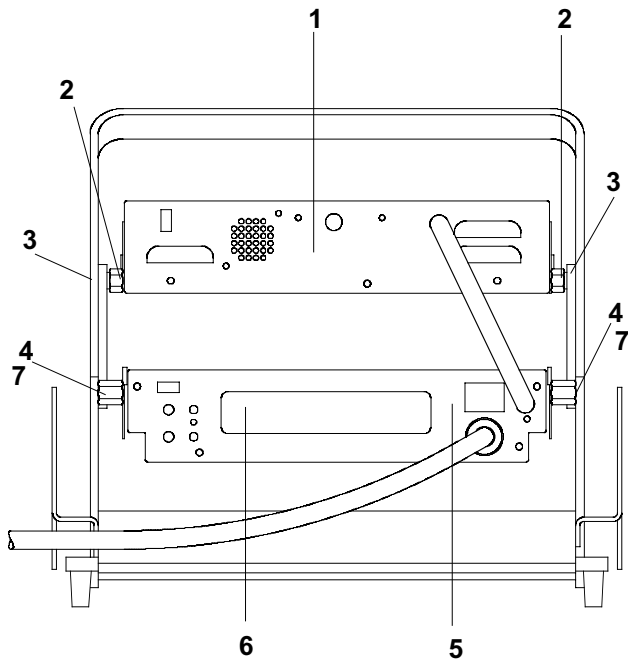

PARTS LIST

ITEM	PART NUMBER	DESCRIPTION
1	411-712	Upper Faceplate
2	411-775	Platen Spacer
3	411-147	Rear Upper Platen Stud
4	411-61	Rear Lower Platen Stud
5	411-705	Lower Faceplate
6	411-707	Overlay
7	411-113	Rear Lower Spacer

INTERNAL VIEW UPPER CONTROL BOX

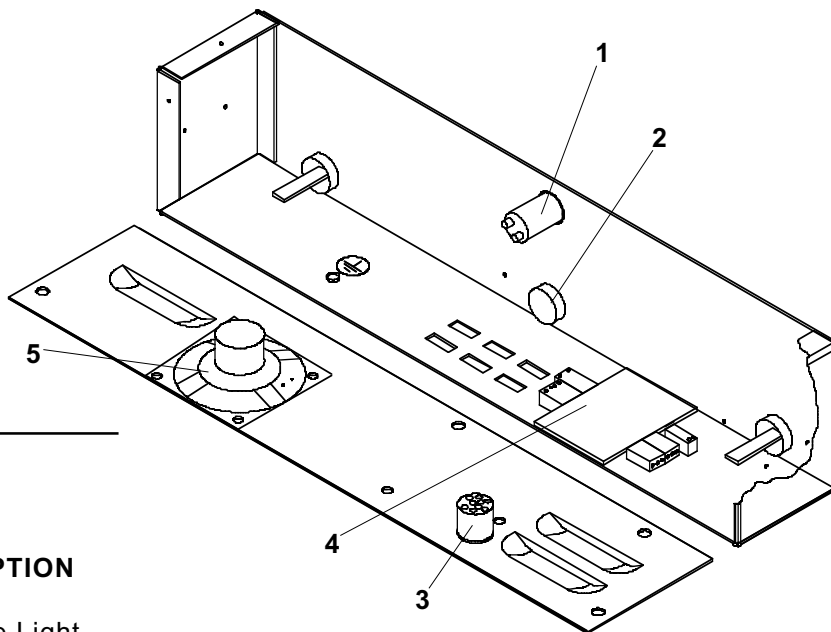

PARTS LIST

ITEM	PART NUMBER	DESCRIPTION
1	213-257S	Bun Done Light
2	411-698S	Upper Probe
3	411-662	Interconnect Cable
4	411-14S	Interconnect Board
5	213-229S	Speaker

INTERNAL VIEW LOWER CONTROL BOX

PARTS LIST

ITEM	PART NUMBER	DESCRIPTION
1	65-058S	Relay, Lower & Upper
2	411-698S	Probe
3	72-414	Power Cord 120/208-240V
4	78-166S	Rocker Switch
5	411-765S	Control PCB 220-230V

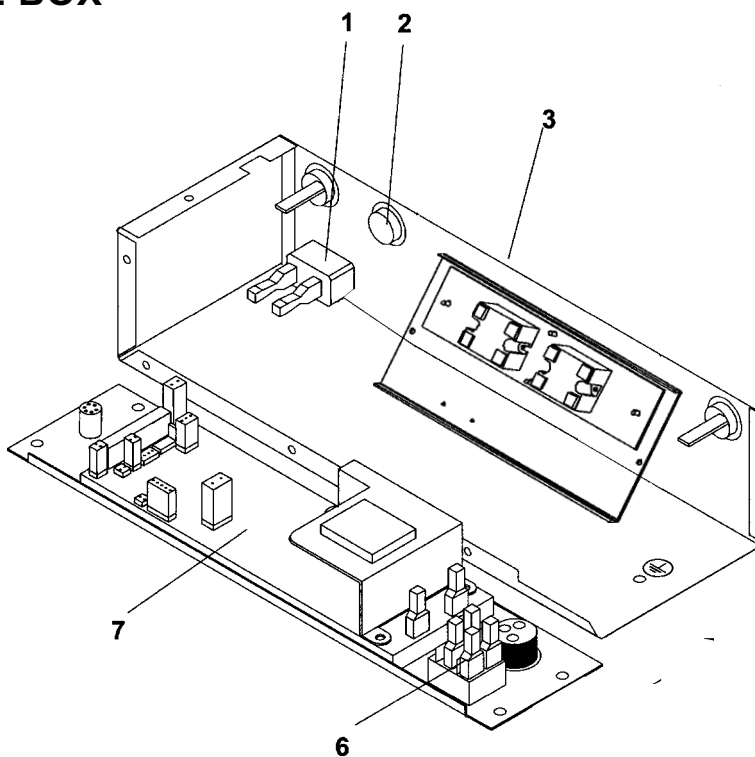

SYMBOLS & TERMS

C - - A Toaster is set on Celsius.

F - - A Toaster is set on Fahrenheit.

A L - Alarm Level setting 1-4.



Sound Button: Used with timer button and temperature button to set alarm level.



Timer Button: Used to view time in run mode. Used to set time in program mode.



Temperature Button: Used to view set point temperature in run mode, and used to set the set point temperature in program mode.



Up Arrow: Used to set time, sound and temperature in program mode.



Down Arrow: Used to set time, sound, and temperature in program mode.

ENERGY SAVING MODE

To conserve energy during non-toasting periods, pull the toaster handle down, so that the timing cycle activates. When the audio alarm goes off, indicating that the toasting time is complete, **DO NOT** pull the handle up. Allow the audio alarm to sound until the alarm shuts off, the display will alternately flash "**Stand**" and "**By**", **indicating** the toaster is in the energy savings mode. The toaster platens will continue to maintain the programmed operating temperature, raising the toaster handle will put the toaster back into the operation mode.

FACTORY PRE-SET

Prince Castle's Solid State Digital Display toasters are pre-set at the factory.

Your toaster model is set for a 100 second toast time, and the temperature is pre-set and calibrated to 149°C.

SET-UP

1. Refer to the nameplate on the control box for the proper operating voltage. Connect the toaster to a grounded receptacle that matches the nameplate voltage information. Press the power switch to the on position, allow the unit 30 minutes to reach

operating temperature.

2. The toaster is factory-set to display temperatures reading in Celsius. When the toaster is turned on, the digital display on the control box will read C--A for Celsius, and the "A" will begin to count down 9 seconds. During this countdown, you can change the temperature display from Celsius to Fahrenheit

figure 1

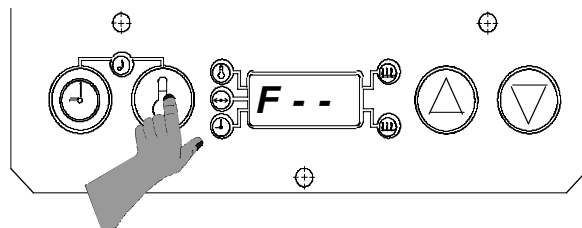

readings. To change temperature display, press and hold the temperature button for six seconds. See figure 1.

3. During the pre-heat cycle, the display will read - L O -. When the platen temperature reaches

figure 2

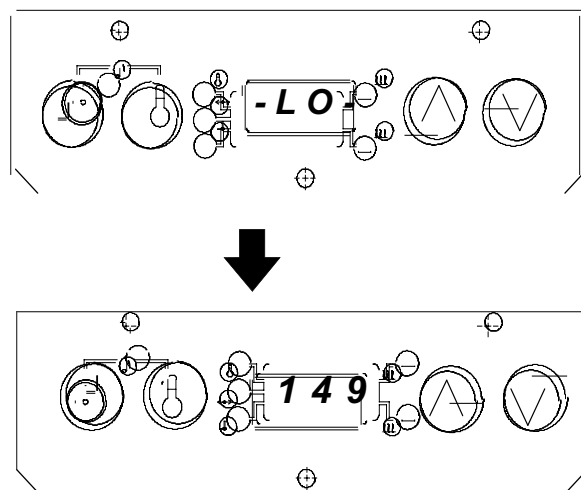

149°C (300°F), the display will begin to show the actual platen temperatures throughout the toasting cycles. See figure 2



Sound Level Adjustment

The audio alarm has four sound levels.

1. Press and hold the time button and temperature buttons simultaneously. The display will show the current sound level. The toasters are factory set at level 4, and the display will read, **A L 4** for **Alarm**

figure 3

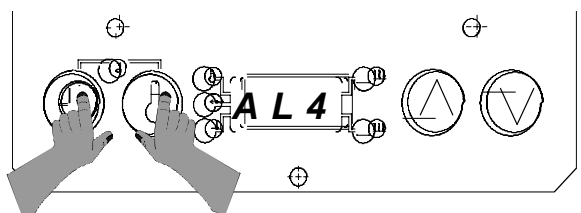

Level 4. See figure 3.

2. While holding the time and temperature buttons, press the up or down arrow buttons to adjust the sound level. A continuous tone will sound. Release all buttons when the desired sound

figure 4

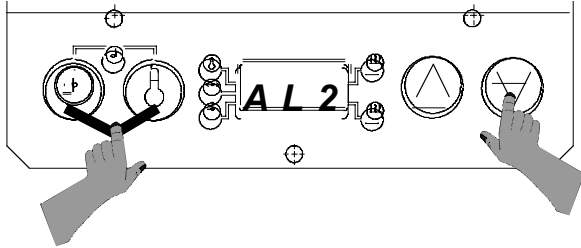

level is reached. The display will show the current sound level. See figure 4.

VIEW SET POINT TEMPERATURE

1. Press and release the temperature button. (Do not hold for more than 6 seconds.) A beep will sound, the temperature indicator will turn on, and the display will show the set point temperature for three seconds. The display will then change to show the actual temperature. See figure 5.

figure 5

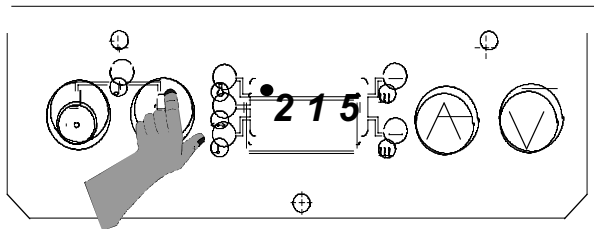

ACTUAL TEMPERATURE

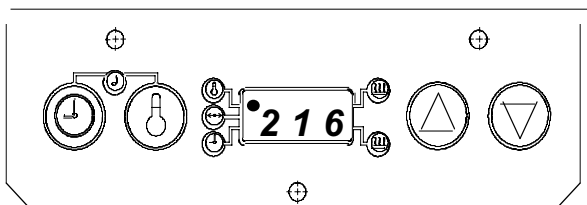

VIEW TIMER SETTING

1. Press and release the time button. (Do not press the time button for more than 6 seconds.) The set time will be displayed for three seconds. If the timer is activated and is in a count-down sequence, the time remaining will be displayed, and will continue to countdown to zero. After three seconds, the display will

figure 6

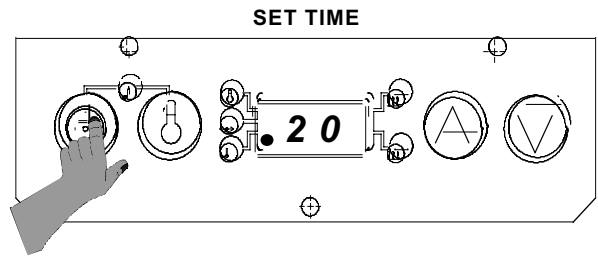

change to show actual platen temperature. See figure 6.

PROGRAMMING

The programming modes are used for setting individual set point temperature, and setting toast times.

Programming the Set Point Temperature

1. Press and hold the temperature button for six seconds. A beep will sound, the temperature indicator light will blink, and the display will show

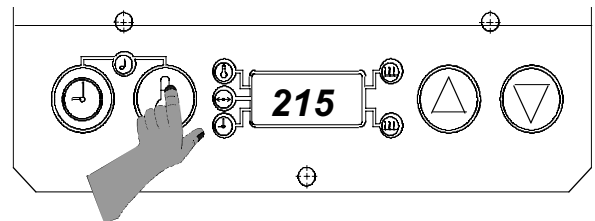

figure 7

the current set point temperature. See figure 7.

2. To change the set point temperature, use the up or down arrow. Once the desired temperature is

figure 8

ADJUST SET POINT TEMPERATURE

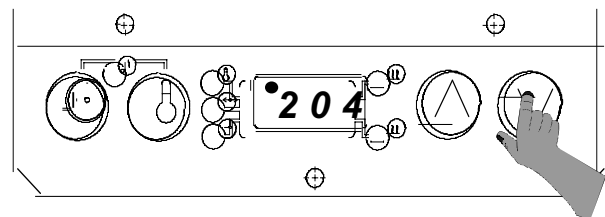

STORE SET POINT TEMPERATURE

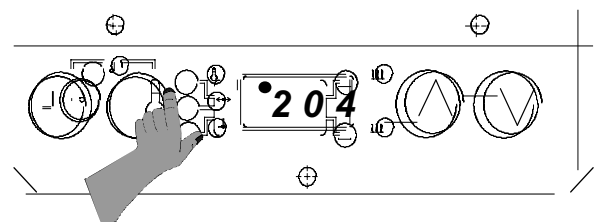

displayed, press the temperature button to store the new setting. See figure 8.

- To cancel the set point programming mode at any time, press and release the time button. The

figure 9

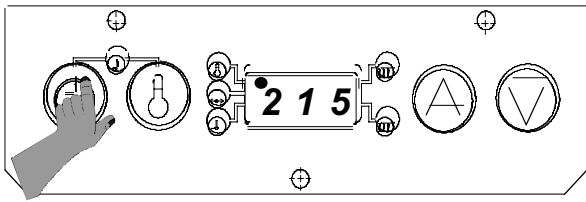

display will change to show the actual platen temperature. See figure 9.

Programming Toast Times

- Press and hold the time button for 6 seconds. A beep will sound, and the time indicator light will

figure 10

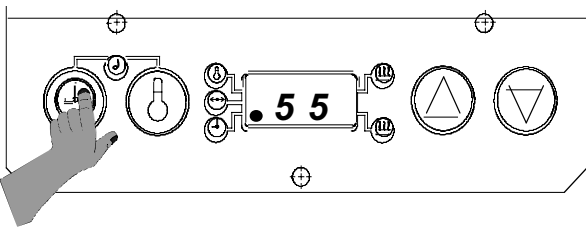

blink. Release the time button to show the current toast time. See figure 10.

- Use the up and down arrow buttons to set your desired toast time. The range is from 1 second to 10 minute. When desired time is reached,

figure 11

SETTING THE NEW TIME

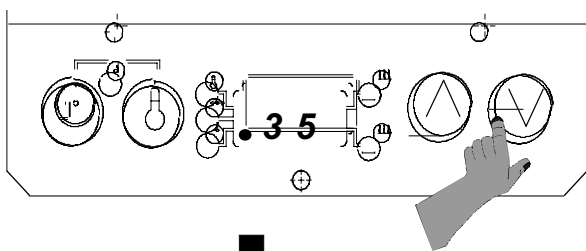

STORING THE NEW TIME

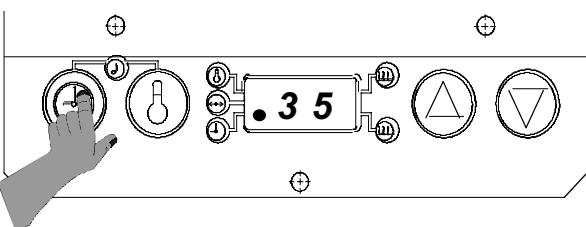

press and release the time button to store the new time. See figure 11.

- To cancel the time set function at any time, press and release the temperature button. The time indicator light will turn off, and the display will change to

figure 12

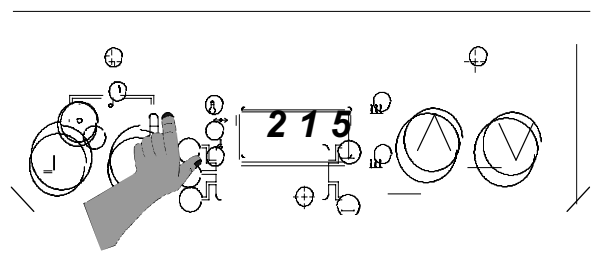

show the actual platen temperature. See figure 12.

SETTING STOP BLOCKS

Stop blocks allow for proper crush when toasting buns. The toaster leaves the factory with the stop blocks set on R/Q.

Dual stop blocks allow you to switch back and forth from Reg/Qtr. bun and Big Mac Bun toasting, or Rib bun or Rye bun toasting.

- Ensure the stop blocks are on the correct setting. There are (6) combination Stop Block Settings:

- | | |
|-----------------|-----------------|
| 1. R/Q / MAC | 4. RIB / RYE |
| 2. R/Q+ / MAC + | 5. RIB+ / RYE + |
| 3. R/Q- / MAC - | 6. RIB- / RYE - |

THE (+) SETTING IS FOR BUNS THAT ARE CUT TOO THICK. THE (-) SETTING IS FOR BUNS CUT TOO THIN. FOR NORMAL SIZE BUNS DO NOT USE (+) or (-) SETTINGS.

[R/Q = REG/QTR]

- Rotate stop blocks by hand to the desired combination bun setting listed above.
- View the stop block setting selected through the index window bracket, which is located over the

figure 13

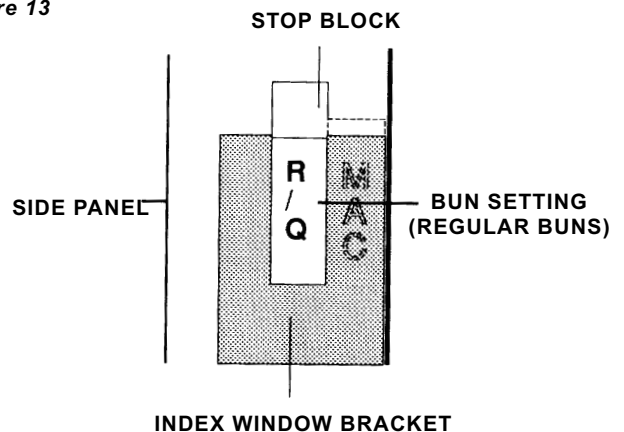

left stop block. See figure 13.

4. To switch between the two types of buns per your stop block setting, locate the selector lever on the front of the toaster frame. Move the lever left or right to switch back and forth between the combination setting. See figure 14.

figure 14

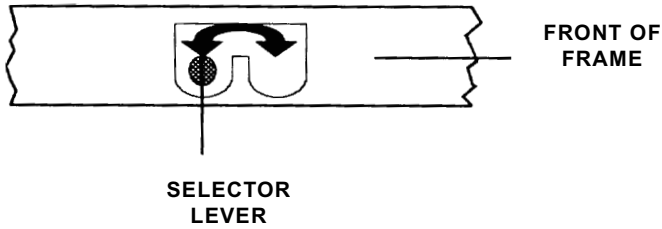

BUN BOARD ADJUSTMENTS

1. Push or pull the bun board handle to desired notched setting as indicated by graphics stamped on top of bun board. See figure 15.
2. Bun board graphics are:
 FRONT = REG, RYE, QTR HEELS
 REAR = BIG MAC, (CROWNS) AND RIB HEELS

figure 15

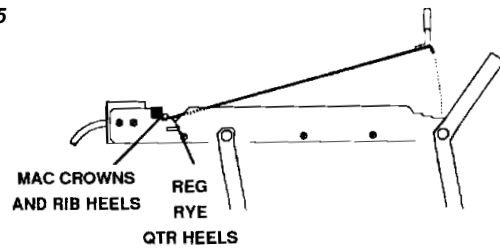

CLEANING

1. Press the power switch to the off position.
2. Unplug toaster.
3. Allow toaster and platens to cool down.
4. Wipe entire platen with clean, damp grill cloth. Full toaster cleaning must be done in the morning when toaster is cold. See your *Planned Maintenance Card* for proper cleaning procedures.

IMPORTANT: Do not drape cord over hot toaster bun board or platen. This will cause cord to burn.

TROUBLESHOOTING GUIDE

PROBLEM	CAUSE	SOLUTION
Platen loose.	Platen bolts loose.	Tighten platen bolts.
Buns being crushed.	Stop blocks not adjusted properly. Warped bun trays.	Adjust stop blocks. Straighten or replace bun trays. Contact Bakery.
No Display.	Fuse Defective.	Check fuse with ohmmeter, reading should be 1-2 ohms.

411 SERIES
UNIVERSAL BUN TOASTER
WIRING DIAGRAM

411-624 REV. --

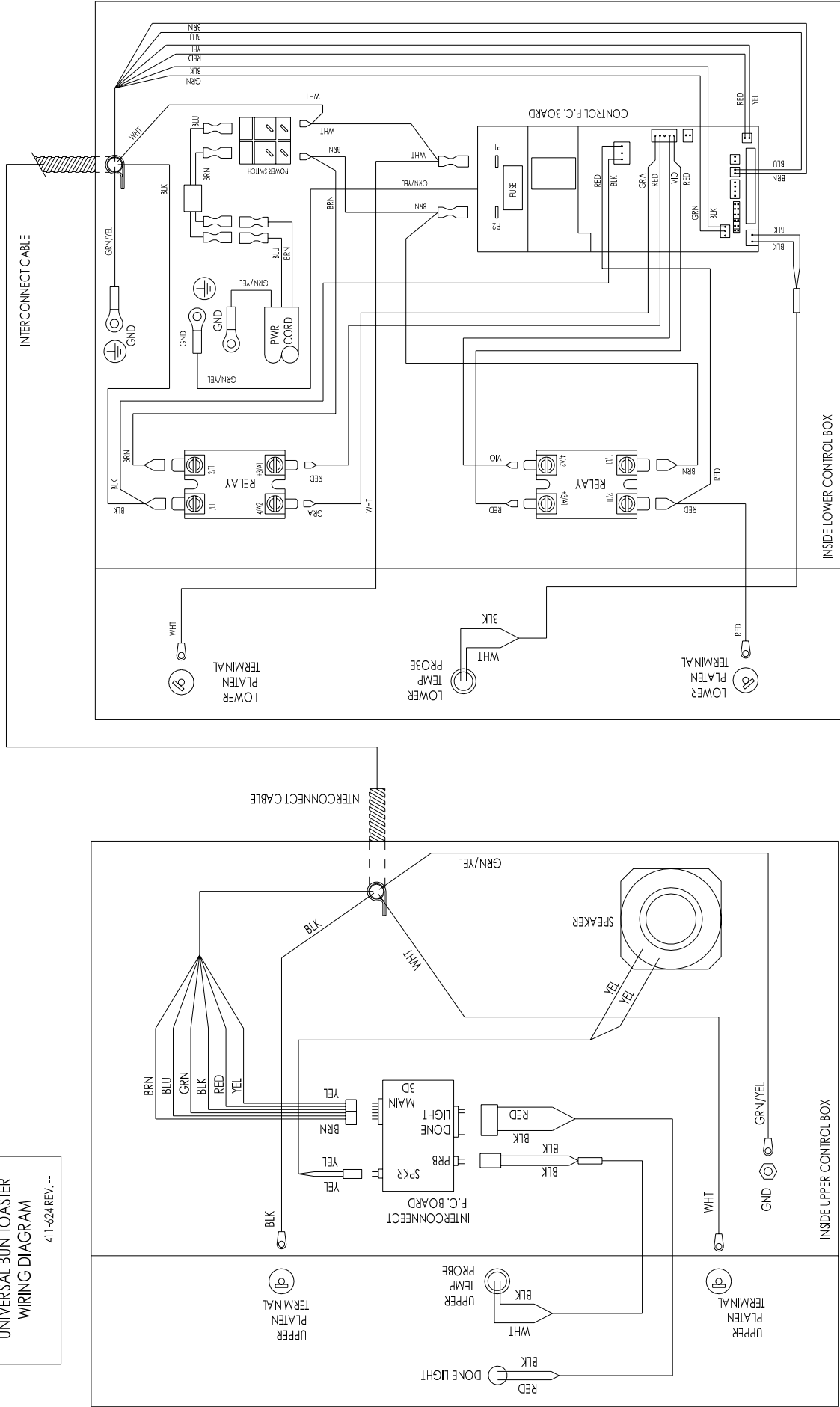



Pictures and additional
information:
Corresponding Chapter of
Equipment Manual

When
Weekly

Tools
*McD Bun Toaster Release
Agent (HCS), customer
paper napkins or paper
towels, protective gloves,
257 cleaning tool.*

Toasters

Prince Castle: Bun Toasters

Precaution

During some checks, live electrical circuits will be exposed, and hot toasting surfaces will be uncovered.

Hazard Communication Standard (HCS) – The procedures on this card include the use of chemical products. These chemical products will be highlighted with bold face letters followed by the abbreviation (HCS) in the tools portion of the procedure. See the Hazard Communication Standard (HCS) Manual for the appropriate Material Safety Data Sheet(s) (MSDS)

Applying Bun Toaster Release Agent

IMPORTANT: Use only McD Toaster Release Agent on bun toasters. Other products may damage bun toasters.

1. Dust all loose crumbs from toaster surfaces.
2. Toaster platens must be well rinsed and dry. McD Bun Toaster Release Agent may be applied to hot toaster platens. Before applying to hot platens, put on protective gloves.
3. To coat top platen surface, thoroughly wet a clean, folded customer napkin or paper towel, with Release Agent.
4. Rub a generous amount of Release Agent over entire surface of a platen until well coated. Use protective gloves and No. 257 cleaning tool.
5. Repeat steps 2 and 3 for other platens, including undersides.

IMPORTANT: Platen undersides and difficult to reach areas can be coated by placing a folded customer napkin or paper towel with Release Agent on No. 257 cleaning tool to apply Release Agent to platen surface.

IMPORTANT: Do not wipe toaster with a damp cloth after Release Agent is applied. This removes Release Agent and causes sticking.

6. If sticking occurs between weekly applications, reapply Release Agent using steps 1-4.

IMPORTANT: Toaster does not need to be recleaned or cooled down before applying Release Agent.

IMPORTANT: Reapply Release Agent weekly, while toaster is cold between monthly cleaning, to all platen surfaces.

When
Monthly

Tools



Digital thermometer with
surface probe.

Check Calibration of Temperature

IMPORTANT: Do not perform this procedure until the toaster has been on for at least 45 minutes and temperature has stabilized. Do not use the toaster during this 45-minute period.









1. Place the rear of the bun board on top of the control box and place the rest of the bun board on top of the platen.

NOTE: On dual platen toasters (411 & 416), the bun board is only required for use on the top platen.

2. On dual platen toasters, use   to select the platen to be calibrated.
3. Center the digital thermometer on the front edge of the platen. When the corresponding LED on the control panel turns on, immediately record the digital thermometer temperature reading.

NOTE: On dual platen toasters (411 & 416), perform step 2 on the lower platen first, then the upper platen.

IMPORTANT: If the temperature reading on the platen is greater than +/- 3°C (+/-5°F) compared to the toaster temperature display, proceed with step 3 to perform calibration. If temperature reading is within range, toaster is functioning properly and does not require calibration.

4. Enter the calibration mode by pressing and holding    for 6 seconds. A beep will sound and the LED next to the calibration symbol will turn on. Release all buttons.
5. Press and release  to select upper platen for calibration or  to select lower platen. Allow 10 seconds for the display to stabilize. The display will show the measured platen temperature value with no offset.
NOTE: On dual platen toasters (411 & 416), calibrate each platen separately.
6. When the corresponding platen LED turns on, use   to adjust the display temperature to match the reading recorded in step 3.
NOTE: Temperature can only be adjusted +/-5°C (+/-9°F).
7. Press  to store the new calibrated temperature and to exit calibration mode.
IMPORTANT: After calibration is complete, allow one full heater on/off cycle to allow the new calibrated temperature to stabilize.

When
Monthly

Tools

McD Hi Temp Grill Cleaner (HCS), McD Bun Toaster Release Agent (HCS), McD No Scratch Pad, base of Big Breakfast container, No. 257 cleaning tool, clean grill cloths (qty. 6-8), customer paper napkins or paper towels, protective gloves.

Clean Nickel Platen

PREPARING BUN TOASTER

1. If toaster is cool, heat to operating temperature.

IMPORTANT: Bun toaster must be at operating temperature for cleaning.

2. Turn toaster power switch to OFF position and unplug power cord.

CAUTION: Failure to unplug power cord before cleaning may cause electrical shock.

3. Remove all buns, bun trays, and bun tray liners from the bun toaster stand.
4. Turn on the grill exhaust fan.
5. Move toaster stand in front of grill.

HOW TO CLEAN

1. Firmly attach McD No-Scratch Pad to cleaning tool. Use only nonabrasive blue No-Scratch pads designed for grill cleaning. Do not use a green pad. It will damage platen surface.
2. Pour one packet of McD Hi-Temp Grill Cleaner into a breakfast container base.
3. Put on protective gloves.
4. Turn bun board upside-down and lay on upper platen or plate.
5. Dip No-Scratch Pad into Hi-Temp Grill Cleaner.
6. Spread cleaner over bun board and lightly scrub until clean. Apply additional cleaner as needed. Place bun board in the back sink area for cooling and rinsing.
7. If toaster is equipped with an aluminum plate, repeat step 6 so both sides of plate are clean.
8. Dip No-Scratch Pad into cleaner and lightly spread a coating of cleaner onto top surface of platen.

IMPORTANT: Do not pour cleaner on surface. Apply only with No-Scratch Pad and Cleaning Tool. Do not scrub while applying cleaner.
9. Repeat Step 8 for all platen surfaces, including undersides.
10. After repeating cleaner, lightly scrub all platen surfaces (including undersides) with No-Scratch Pad until all soil liquifies. Apply additional cleaner to cleaning as needed.
11. Remove No-Scratch Pad from cleaning tool. Fold a clean, damp grill cloth lengthwise and lay it over the end of the cleaning tool. Thoroughly rinse platens, including undersides, by wiping with a damp grill cloth. Before wiping platens, always rinse grill cloth in clear water and wring it out until no soil is seen.

IMPORTANT: Thorough rinsing of the platen is required to ensure proper release agent performance. Rinse platens with clean grill cloths until no soil is seen on the cloth.

CAUTION: Do not pour water on platens or use dripping wet grill cloths.

12. Repeat the rinsing procedure in Step 11 with a fresh, clean, damp grill cloth to ensure all cleaner and soil are removed from platens.
13. Wipe remaining parts of the toaster with a clean damp cloth.
14. Take bun tray platform, bun board, and aluminum plate to back sink. Scrub with a pot brush or No-Scratch Pad in a solution of McD All Purpose Concentrate. Do not use abrasive pads. Rinse parts under running water and let air dry.

When
Monthly

Tools
*Adjustable wrench,
flatblade screwdriver*

Tighten Platen and Leg Bolts

TIGHTEN PLATEN BOLTS

1. Turn the power switch to the OFF Position.
2. Unplug the power cord.
3. Allow toaster to cool before proceeding.
4. Using an adjustable wrench, tighten the platen bolts which hold handle in upright position.

TIGHTEN LEG BOLTS

1. Carefully turn the toaster upside down for access to legs.
2. Adjust and tighten leg bolts to obtain a level setting for toasting.
3. Set toaster right side up and check for level setting.
4. Adjust leg bolts as necessary until toaster sits level.
5. Plug the power cord into the appropriate electrical receptacle.
6. If the toaster is about to be used, turn the power switch to ON position.

When
Monthly

Tools
Pliers, hammer, file

Check Bun Tray Platforms, Bun Board, Bun Trays and Spatulas

IMPORTANT: This check procedure should be conducted while the platforms, trays and spatulas are cold. It should be done for all spatulas, trays and platforms.

BUN SPATULA

1. Lay the spatula on a flat work table top.
2. Make sure the entire surface is flat, including the front edge. The front end of bun spatula must be free from necks and burrs.
3. Sharpen front edge of spatula so all nicks and burrs are removed.

IMPORTANT: Straightening curled corners with pliers and hammer middle part of the tray flat.

BUN TRAY

1. Lay the track on a flat work tabletop and inspect for flatness.
2. Inspect the tray for uniform height.
3. Straightened curled corners with pliers and hammer middle part of the tray flat.

BUN TRAY PLATFORM

1. Remove the platform from the lower part of the toaster.
2. Lay the platform on a flat work tabletop and inspect the entire surface to make sure it is flat.
3. Using pliers or a hammer, straighten as needed.
4. Reinstall the platform into toaster.

BUN BOARD

1. Remove the bun board from toaster.
2. Lay the bun board on a flat work tabletop and inspect for flatness.
3. Measure the distance between the tabletop and the bottom side of the bun board in the front, center, and rear. It should be approximately 1/2" (13mm) for all toasters except Big Mac 412 and 416 series, and approximately 1/2" (19mm) for Big Mac Toasters.
4. Bend as needed to maintain flatness.