

Salvajor Model MSS

Manual Start/Stop

PRE-WIRED CONTROL PANEL PARTS BREAKDOWN

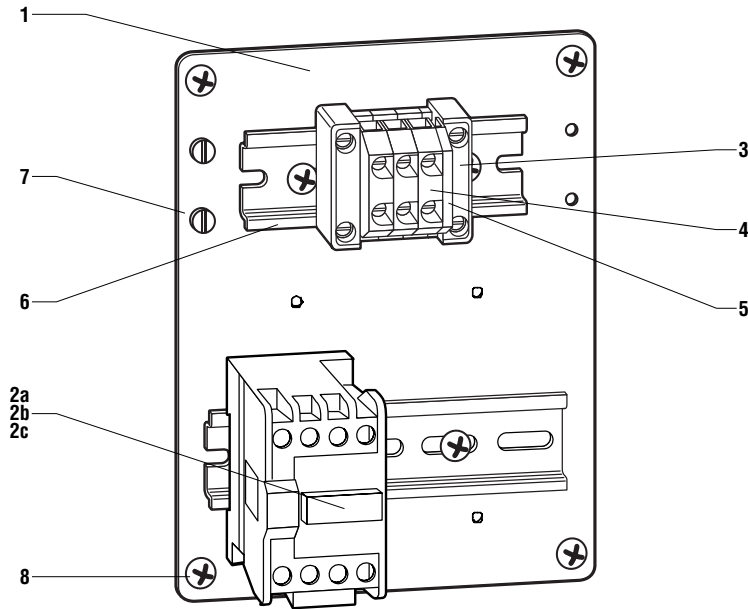

MSS Item Numbers		
VOLTAGE	PHASE	ITEM NO.
115	1	MSS4
208 or 230	1	MSS5
208 or 230	3	MSS7
460	3	MSS9

ITEM	PART NO.	DESCRIPTION
1	79IP	Inner Panel MSS
2a	994006	Contactora 115V
2b	994007	Contactora 208-230V
2c	994008	Contactora 460V
3	994294	End Clamp
4	994292	Terminal Block
5	994293	End Barrier
6	994005	Din Rail Mounting Track
7	SCR1032	Ground Screw 10-32
8	997093	Screw 10-32 X 3/8"
9	79GA	Lid Gasket Assembly
10	ABD100B	Button Start
11	ABD200A	Button Stop
12	79BA	7" X 9" Box Assembly
13	997032	Screw 10-32 X 5/8"

7" x 9" Box Assembly

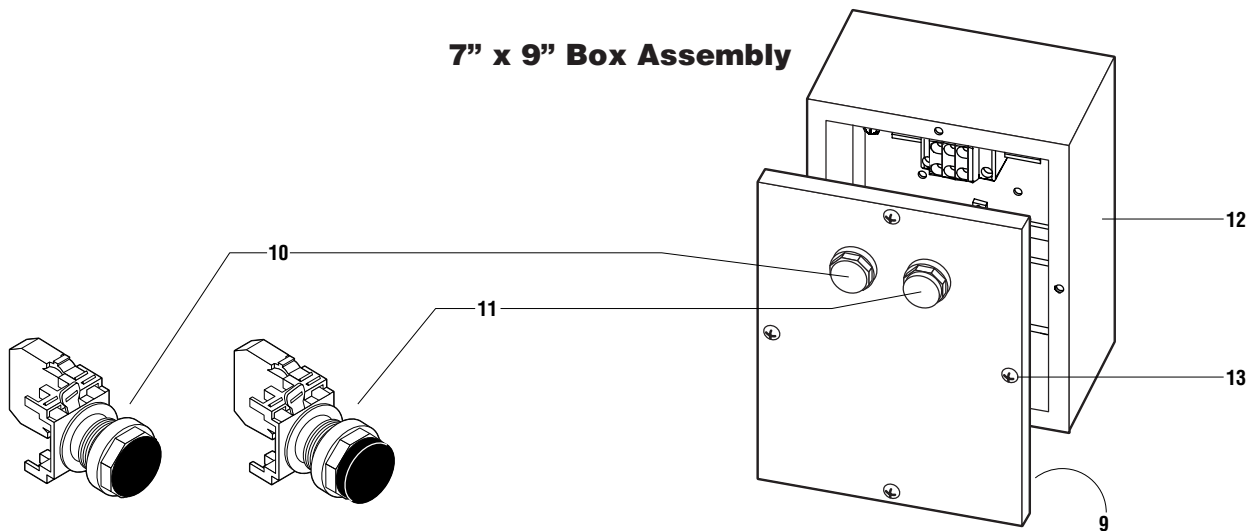

(Model MSS-LD on other side)

Salvajor Model MSS-LD

Manual Start/Stop with Line Disconnect

PRE-WIRED CONTROL PANEL PARTS BREAKDOWN

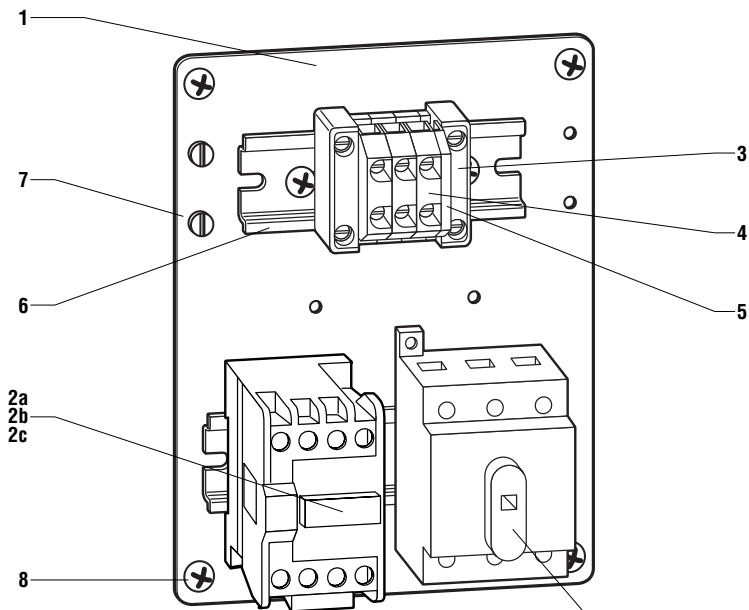

MSS-LD Item Numbers		
VOLTAGE	PHASE	ITEM NO.
115	1	MSSLD4
208 or 230	1	MSSLD5
208 or 230	3	MSSLD7
460	3	MSSLD9

ITEM	PART NO.	DESCRIPTION
1	79IP	Inner Panel MSS
2a	994006	Contactora 115V
2b	994007	Contactora 208-230V
2c	994008	Contactora 460V
3	994294	End Clamp
4	994292	Terminal Block
5	994293	End Barrier
6	994005	Din Rail Mounting Track
7	SCR1032	Ground Screw 10-32
8	997093	Screw 10-32 X 3/8"
9	79GA	Lid Gasket Assembly
10	ABD100B	Button Start
11	ABD200A	Button Stop
12	79BA	7" X 9" Box Assembly
13	997032	Screw 10-32 X 5/8"
14	980138	Line Disconnect Assembly
14a	994263	Line Disconnect Handle

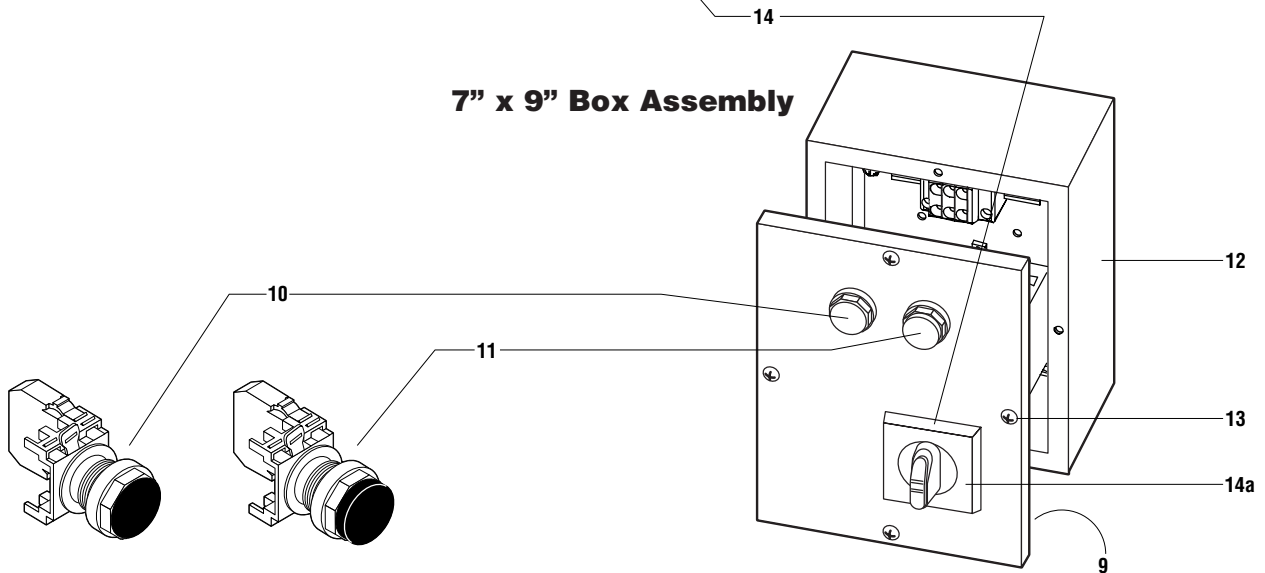

(Model MSS on other side)



The Salvajor Company 4530 East 75th Terrace Kansas City, Missouri 64132-2081, USA

1-800-821-3136

(816) 363-1030

FAX: 1-800-832-9373

www.salvajor.com

Email: sales@salvajor.com

service@salvajor.com

Manufacturers of Commercial Food Waste Disposing Systems since 1944