

# INSTALLATION MANUAL FOR UNDERCOUNTERS, WORKTOPS, SANDWICH/SALAD & PIZZA PREP



TUC-27G



TSSU-48-10



TUC-60D-4

TPP-67D-2

TWT-93

TPP-93D-6

## TABLE OF CONTENTS

### ► **Safety Information**

Safety Precautions	1
Proper Disposal	2
Connecting Electricity	3
Adapter Plugs	3

### ► **Installation / Operation Instructions**

Ownership	4
Required Tools	4
Uncrating	4
Locating & Installation of Leg/Castors	5
Pizza Prep Tables	6
Installing TSSU Hood Cover	6
Leveling Cabinet	7
Electrical Instructions	7
Wire Gauge Chart	8
Start-up	9
Cabinet Air-Flow	9
Temperature Control Adjustment	10
TSSU-27-12M-C Chiller Hose	11
Shelving Install/Operation & Light Switch	12

### ► **Maintenance, Care & Cleaning**

Cleaning Condenser Coil	13-14
Stainless Steel Equipment Care & Cleaning	15-16
Composite Cutting Board Maintenance	16
Warranty (U.S.A. & Canada Only!)	17

\*Spanish, German, French, and Dutch versions included.

### CONGRATULATIONS!

*You have just purchased the finest commercial refrigerator available. You can expect many years of trouble-free operation.*

# UNDERCOUNTERS, WORKTOPS, SANDWICH/SALAD & PIZZA PREP

# NOTICE TO CUSTOMER:



**Loss Or Spoilage Of Products  
In Your Refrigerator/Freezer  
Is NOT Covered By Warranty.  
In Addition To Following  
Recommended Installation  
Procedures You Must Run  
The Refrigerator/Freezer  
24 Hours Prior To Usage.**

True Manufacturing Company, Inc.

SAFETY INFORMATION

# **How to Maintain Your Unit to Receive the Most Efficient and Successful Operation**

*You have selected one of the finest commercial refrigeration units made. It is manufactured under strict quality controls with only the best quality materials available. Your TRUE cooler when properly maintained will give you many years of trouble-free service.*

## **WARNING!**

***Use this appliance for its intended purpose as described in this Owner Manual.***

***This cabinet contains fluorinated greenhouse gas covered by the Kyoto Protocol (please refer to cabinet's inner label for type and volume, GWP of 134a= 1,300. R404a= 3,800).***

## **SAFETY PRECAUTIONS**

*When using electrical appliances, basic safety precautions should be followed, including the following:*

- This refrigerator must be properly installed and located in accordance with the Installation Instructions before it is used.
- Do not allow children to climb, stand or hang on the shelves in the refrigerator. They could damage the refrigerator and seriously injure themselves.
- Do not touch the cold surfaces in the refrigerator compartment when hands are damp or wet. Skin may stick to these extremely cold surfaces.
- Do not store or use gasoline or other flammable vapors and liquids in the vicinity of this or any other appliance.
- Keep fingers out of the "pinch point" areas; clearances between the doors and between the doors and cabinet are necessarily small; be careful closing doors when children are in the area.

**NOTE:** *We strongly recommend that any servicing be performed by a qualified individual.*

- Unplug the refrigerator before cleaning and making repairs.
- Setting temperature controls to the 0 position does not remove power.

SAFETY INFORMATION

**DANGER!**  
**RISK OF CHILD ENTRAPMENT**

**PROPER DISPOSAL OF THE REFRIGERATOR**

---

Child entrapment and suffocation are not problems of the past. Junked or abandoned refrigerators are still dangerous... even if they will sit for “just a few days.” If you are getting rid of your old refrigerator, please follow the instructions below to help prevent accidents.

***Before You Throw Away Your Old Refrigerator or Freezer:***

- Take off the doors.
- Leave the shelves in place so that children may not easily climb inside.

***Refrigerant Disposal***

Your old refrigerator may have a cooling system that uses “Ozone Depleting ” chemicals. If you are throwing away your old refrigerator, make sure the refrigerant is removed for proper disposal by a qualified service technician. If you intentionally release any refrigerants you can be subject to fines and imprisonment under provisions of the environmental regulations.

**USE OF EXTENSION CORDS**

---

***NEVER USE AN EXTENSION CORD! TRUE will not warranty any refrigerator that has been connected to an extension cord.***

SAFETY INFORMATION

# WARNING!

## HOW TO CONNECT ELECTRICITY

*Do not, under any circumstances, cut or remove the third (ground) prong from the power cord.  
For personal safety, this appliance must be properly grounded.*

The power cord of this appliance is equipped with a 3-prong (grounding) plug which mates with a standard 3-prong (grounding) wall outlet to minimize the possibility of electric shock hazard from this appliance.

Have the wall outlet and circuit checked by a qualified electrician to make sure the outlet is properly grounded.

If the outlet is a standard 2-prong outlet, it is your personal responsibility and obligation to have it replaced with the properly grounded 3-prong wall outlet.

The refrigerator should always be plugged into it's own individual electrical circuit, which has a voltage rating that matches the rating plate.

This provides the best performance and also prevents overloading building wiring circuits which

could cause a fire hazard from overheated wires.

Never unplug your refrigerator by pulling on the power cord. Always grip plug firmly and pull straight out from the outlet.

Repair or replace immediately all power cords that have become frayed or otherwise damaged. Do not use a cord that shows cracks or abrasion damage along its length or at either end.

When removing the refrigerator away from the wall, be careful not to roll over or damage the power cord.

## USE OF ADAPTER PLUGS

*NEVER USE AN ADAPTER PLUG! Because of potential safety hazards under certain conditions, we strongly recommend against the use of an adapter plug.*

**(North America Use Only!)**

NEMA plugs

TRUE uses these types of plugs.  
If you do not have the right outlet  
have a certified electrician install  
the correct power source.



115/60/1  
NEMA-5-15R

INSTALLATION / OPERATION INSTRUCTIONS

**INSTALLATION / OPERATION INSTRUCTIONS**

**OWNERSHIP**

To insure that your unit works properly from the first day, it must be installed properly. We highly recommend a trained refrigeration mechanic and electrician install your **TRUE** equipment. The cost of a professional installation is money well spent.

Before you start to install your **TRUE** unit, carefully inspect it for freight damage. If damage is discovered, immediately file a claim with the delivery freight carrier.

*TRUE is not responsible for damage incurred during shipment.*

**REQUIRED TOOLS**

- Adjustable Wrench
- Phillips Head Screwdriver
- Level

**UNCRATING**

The following procedure is recommended for uncrating the unit:

- A.** Remove the outer packaging, (cardboard and bubbles or styrofoam corners and clear plastic). Inspect for concealed damage. Again, immediately file a claim with the freight carrier if there is damage.
- B.** Move your unit as close to the final location as possible before removing the wooden skid.
- C.** Remove door bracket on swing glass door models (see image 1-2).

*Note: Keys for coolers with door locks are located in warranty packets.*

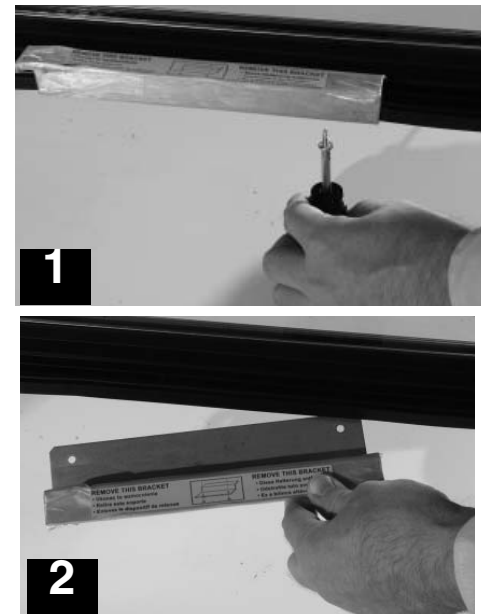

Glass Door Models Only.

**REMOTE UNITS (This section applies to remotes only!)**

- Remote cabinets must be ordered as remote. We do not recommend converting for a standard self contained to remote system.
- All remote cabinets must be hard wired.
- No castors available.
- All remote cabinets come standard using 404A refrigerant.
- All remote units come standard with expansion valve, liquid line solenoid, heated condensate pan, and defrost timer when applicable.

- Contact TRUE Technical Service for BTU requirements.
- No wiring necessary between cabinet and condensing unit.
- All remote condensing units purchased from TRUE are 208/230 volts single phase.

***If you have any questions regarding this section, please call TRUE at 1-(800)-325-6152.***

INSTALLATION / OPERATION INSTRUCTIONS

**LOCATING**

**A.** Place packing material behind cabinet as a cushion. Carefully lay the unit on its back to remove skid.

When lifting unit remember to leave the cabinet upright for 24 hours before plugging into power source.

**B.** Remove skid by unscrewing all base rail anchor brackets. Place skid to the side.  
**C.** Carefully lift cabinet upright.

Removing skid from bottom of cabinet.



**D.** Before removing unit off the shipping skid be sure not to damage drain pan at the base of the unit

**INSTALLATION OF LEGS AND CASTORS**

*Important Safeguard for installation of leg/castor (Images 1-5 demonstrate procedure)*

**Securing Castors and Legs**

To obtain maximum strength and stability of the unit, it is important that you make sure each castor is secure. Legs are hand-tightened securely against the lower rail assembly. The bearing race on the castor of the top edge of the leg must make firm contact with the rail.

**Unit leveling**

*Four leveling shims have been provided for leveling castored units positioned on uneven floors. Shims must be positioned between rail end and bearing race. TRUE requires a four shim limit to each individual castor.*

**A.** Turn the bearing race counter-clockwise until the cabinet is level. Level front to back and side to side. (diagonally)

- B.** Install the desired number of shims, making sure the slot of the shim is in contact with the threaded stem of the castor.
- C.** If more than one shim is used, turn the slot at a 90° angle so they are not in line.
- D.** Turn the bearing race clockwise to tighten and secure the castor by tightening the anchoring bolt with a 3/4 inch open-end wrench or the tool provided.

**CAUTION**

*To avoid damage to lower rail assembly, slowly raise unit to upright position.*



**1** Thread castor into the underside of cabinet frame rail.



**2** For leveling, insert the shim between the castor and frame rail.



**3** Use the tool provided to tighten the castor into place.



**4** Thread leg into cabinet bottom frame rail.



**5** The end of the leg is adjustable to easy leveling.

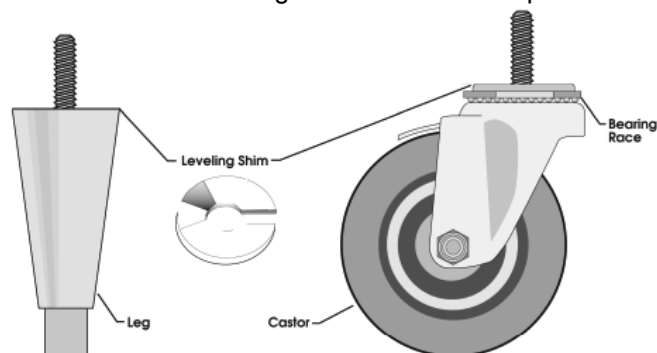

INSTALLATION / OPERATION INSTRUCTIONS

**PIZZA PREP TABLES**

- A. Remove rear grill and thread electric cord through grommet in grill.
- B. Replace grill.
- C. Align cutting board with Rivnuts and attach retainer clip to table top (figure 1).
- D. Install the lid brackets. Note that there is a specifically designed left, center (if applicable), and right bracket.

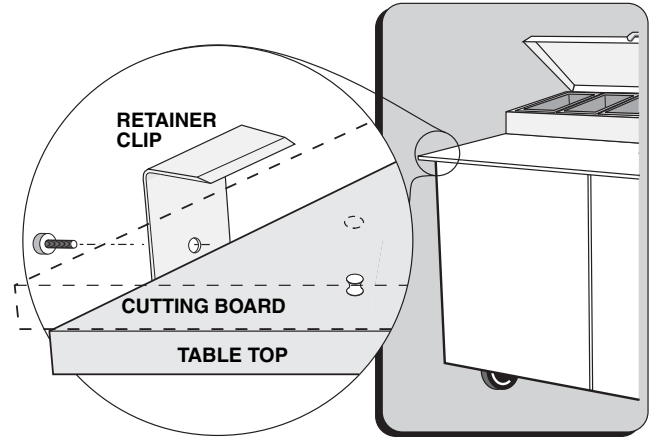

Figure 1.

**ANCHORING THE TSSU HOOD COVER**

*TSSU Hood Installation Instruction*

- A. Remove rear grill and thread electric cord This is True’s recommended procedure for installing the fasteners required to connect the sandwich salad hood cover to the hood.

See callout #1 on the illustration.

Assembly

1. Locate the hood cover, (packaged within the cardboard container on top of the salad sandwich unit), and position under the hood.
2. Remove the slotted thumb screw from hood by backing out the factory installed, slotted thumb screw. See diagram of slotted screw and callout #2.
3. Place hood cover into final position, (beneath hood), align hood hinge pin with anchor hole on hood cover and re-attach fastener by replacing thumb screw into hinge pin.
4. Repeat procedure for both ends of hood.

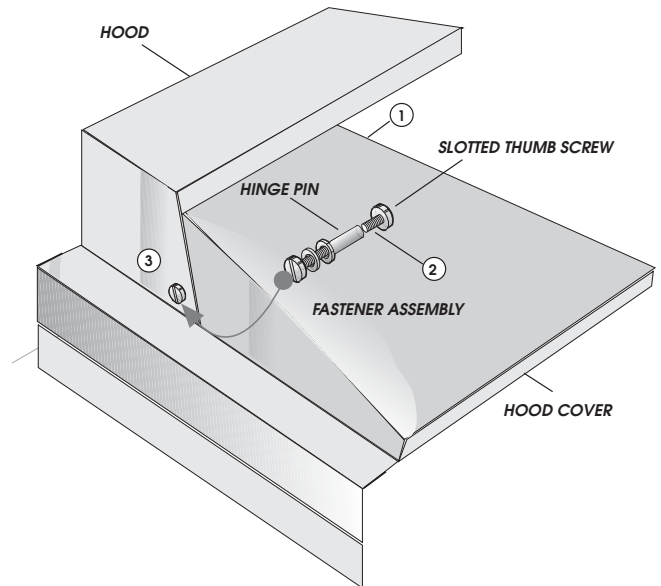



INSTALLATION / OPERATION INSTRUCTIONS

**LEVELING**

- A. Set unit in its final location. Be sure there is adequate ventilation in your room. Under extreme heat conditions, (100°F+, 38°C+), you may want to install an exhaust fan.

**Warning**

*Warranty is void if ventilation is insufficient.*

- B. Proper leveling of your TRUE cooler is critical to operating success (for non-mobile models). Effective condensate removal and door operation will be effected by leveling.
- C. The cooler should be leveled from inside the cabinet. Place a level on the inside floor of the unit front to back and side to side.

- D. Ensure that the drain hose or hoses are positioned in the pan.
- E. Free plug and cord from inside the lower rear of the cooler (do not plug in).
- F. The unit should be placed close enough to the electrical supply so that extension cords are never used.

**Warning**

*Compressor warranties are void if the unit is more than 7 ft. (2.1m) from plug-in connection. TRUE will not warranty any units that are connected to an extension cord.*

**ELECTRICAL INSTRUCTIONS**

- A. Before your new unit is connected to a power supply, check the incoming voltage with a voltmeter. If anything less than 100% of the rated voltage for operation is noted, correct immediately.
- B. All units are equipped with a 7 ft. (2.1m) service cord, and must be powered at proper operating voltage at all times. Refer to cabinet data plate for this voltage.

*TRUE requires that a sole use circuit be dedicated for the unit. Failure to do so voids warranty.*

**WARNING**

*Compressor warranties are void if compressor burns out due to low voltage.*

**WARNING**

*Power supply cord ground should not be removed!*

**NOTE**

*To reference wiring diagram - Remove front louvered grill, wiring diagram is positioned on the inside cabinet wall.*

INSTALLATION / OPERATION INSTRUCTIONS

**CONDUCTORS AND CIRCUITS**

**Wire Gauge for 2% Voltage Drop in Supply Circuits**

115 Volt Amps	<i>Distance In Feet To Center of Load</i>											
	20	30	40	50	60	70	80	90	100	120	140	160
2	14	14	14	14	14	14	14	14	14	14	14	14
3	14	14	14	14	14	14	14	14	14	14	14	12
4	14	14	14	14	14	14	14	14	14	12	12	12
5	14	14	14	14	14	14	14	12	12	12	10	10
6	14	14	14	14	14	14	12	12	12	10	10	10
7	14	14	14	14	14	12	12	12	10	10	10	8
8	14	14	14	14	12	12	12	10	10	10	8	8
9	14	14	14	12	12	12	10	10	10	8	8	8
10	14	14	14	12	12	10	10	10	10	8	8	8
12	14	14	12	12	10	10	10	8	8	8	8	6
14	14	14	12	10	10	10	8	8	8	6	6	6
16	14	12	12	10	10	8	8	8	8	6	6	6
18	14	12	10	10	8	8	8	8	8	8	8	5
20	14	12	10	10	8	8	8	6	6	6	5	5
25	12	10	10	8	8	6	6	6	6	5	4	4
30	12	10	8	8	6	6	6	6	5	4	4	3
35	10	10	8	6	6	6	5	5	4	4	3	2
40	10	8	8	6	6	5	5	4	4	3	2	2
45	10	8	6	6	6	5	4	4	3	3	2	1
50	10	8	6	6	5	4	4	3	3	2	1	1

**Wire Gauge for 2% Voltage Drop in Supply Circuits**

230 Volts Amps	<i>Distance In Feet To Center of Load</i>											
	20	30	40	50	60	70	80	90	100	120	140	160
5	14	14	14	14	14	14	14	14	14	14	14	14
6	14	14	14	14	14	14	14	14	14	14	14	12
7	14	14	14	14	14	14	14	14	14	14	12	12
8	14	14	14	14	14	14	14	14	14	12	12	12
9	14	14	14	14	14	14	14	14	12	12	12	10
10	14	14	14	14	14	14	14	12	12	12	10	10
12	14	14	14	14	14	14	12	12	12	10	10	10
14	14	14	14	14	14	12	12	12	10	10	10	8
16	14	14	14	14	12	12	12	10	10	10	8	8
18	14	14	14	12	12	12	10	10	10	8	8	8
20	14	14	14	12	10	10	10	10	10	8	8	8
25	14	14	12	12	10	10	10	10	8	8	6	6
30	14	12	12	10	10	10	8	8	8	6	6	6
35	14	12	10	10	10	8	8	8	8	6	6	5
40	14	12	10	10	8	8	8	6	6	6	5	5
50	12	10	10	8	6	6	6	6	6	5	4	4
60	12	10	8	6	6	6	6	6	5	4	4	3
70	10	10	8	6	6	6	5	5	4	4	2	2
80	10	8	8	6	6	5	5	4	4	3	2	2
90	10	8	6	6	5	5	4	4	3	3	1	1
100	10	8	6	6	5	4	4	3	3	2	1	1

INSTALLATION / OPERATION INSTRUCTIONS

**STARTUP**

- A. The compressor is ready to operate. Plug in the cooler.
- B. Temperature control set at No. 4 position gives refrigerators an approximate temperature of 35°F. Allow unit to function several hours, completely cooling cabinet before changing the control setting.
- C. Excessive tampering with the control could lead to service difficulties. Should it ever become necessary to replace temperature control, be sure it is ordered from your TRUE dealer or recommended service agent.
- D. Good air flow in your TRUE unit is critical. Be careful to load product so that it neither presses against the back wall, nor comes within four inches of the evaporator housing. Refrigerated air off the coil must circulate down the back wall.

**NOTE**

*If the cooler is disconnected or shut off, wait five minutes before starting again.*

**RECOMMENDATION**

*Before loading product we recommend you run your TRUE unit empty for two to three days. This allows you to be sure electrical wiring and installation are correct and no shipping damage has occurred. Remember, our factory warranty does not cover product loss!*

**REPLACEMENT PARTS**

*TRUE maintains a record of the cabinet serial number for your cooler. If at any time during the life of your cooler, a part is needed, you may obtain this part by furnishing the model number and serial number to the company from whom you purchased the cooler. Call Toll-Free: (800)-424-TRUE (Direct to Parts Department). (800)-325-6152 (U.S.A. & Canada only) or call: (636)-240-2400.*

**AIR-FLOW THROUGHOUT CABINET (TPP UNITS ONLY!)**

**WARNING:**

**REMOVAL OF BAFFLES IN CONDIMENT PAN AREA WILL ADVERSELY AFFECT REFRIGERATION PERFORMANCE. PLEASE LEAVE THE BAFFLES IN THE CORRECT LOCATION.** (See images below)

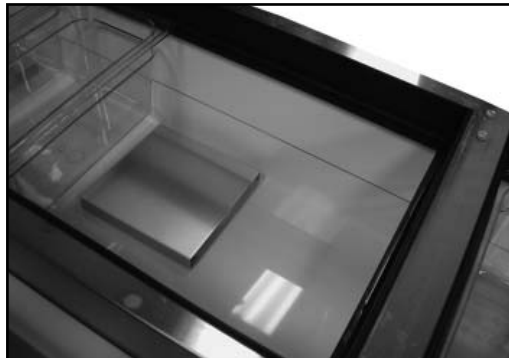
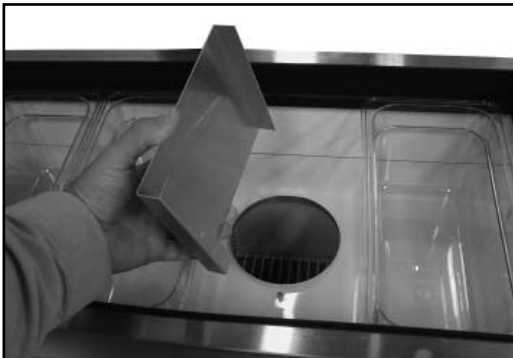

Baffle in the correct location.

INSTALLATION / OPERATION INSTRUCTIONS

**TEMPERATURE CONTROL ADJUSTMENT FOR HIGH ALTITUDE ONLY!**

**TERMS:**

Cut-out - Temperature sensed by the controller that shuts the compressor off.

Cut-in - Temperature sensed by the controller that turns the compressor on.

**REQUIRED TOOLS**

- Phillips Head Screwdriver
- 5/64" or 2 mm Allen Wrench
- T-7 Torx Wrench

\_\_\_\_\_ **STEP 1** \_\_\_\_\_

Unplug the cooler.

\_\_\_\_\_ **STEP 2** \_\_\_\_\_

Remove the screws that secure the temperature control to the inset box lower left side of the cabinet (when facing the front of the cabinet).

\_\_\_\_\_ **STEP 3** \_\_\_\_\_

Pull out gently from cabinet.

**NOTE:**

Mechanical temperature controllers are affected when functioning at high altitude. The cut-in and cut-out temperatures will be colder than when the controller functions closer to sea level

\_\_\_\_\_ **STEP 4** \_\_\_\_\_

For high elevation installations, it may be necessary to “warm-up” the set points. To make the adjustment, insert the appropriate tool in each adjustment screw and turn 1/4 of a revolution clockwise (to the right). This procedure will adjust both the cut-in and cut-out about 2°F warmer.

\_\_\_\_\_ **STEP 5** \_\_\_\_\_

Make sure to reconnect the pink wire to the proper spade terminal when reinstalling.

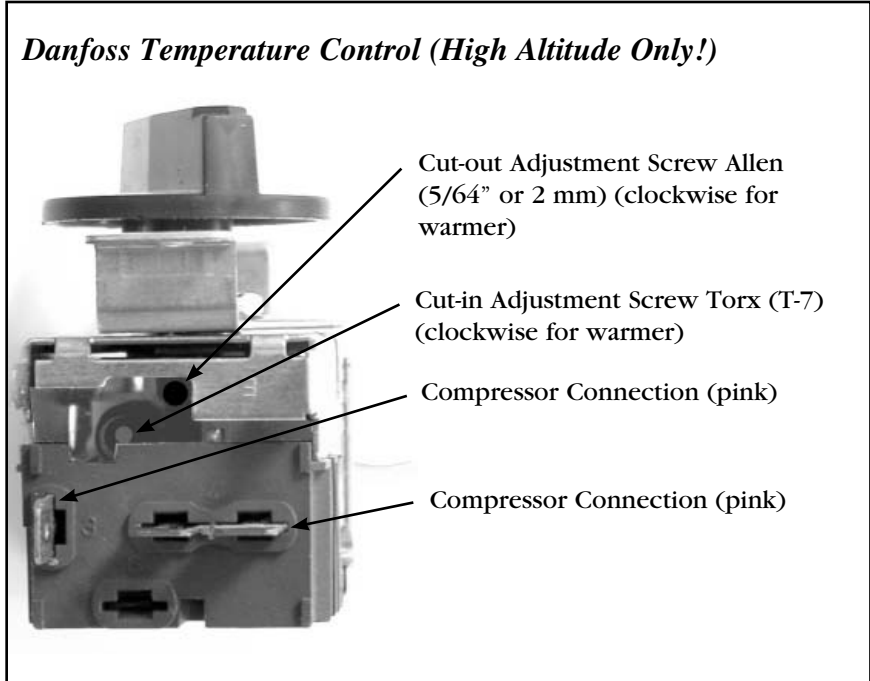

INSTALLATION / OPERATION INSTRUCTIONS

**TSSU-27-12M-C CHILLER HOSE**

**Required Tools:**

- Slotted screwdriver
- Needle nose pliers
- Hex-head nut driver

**Kit Components:**

- Hose Cleaning Brush

1. **WARNING:** Power must be disconnected before beginning this procedure.

2. Remove the condiment pans.



Figure 1.

3. Remove the shelving from the unit.

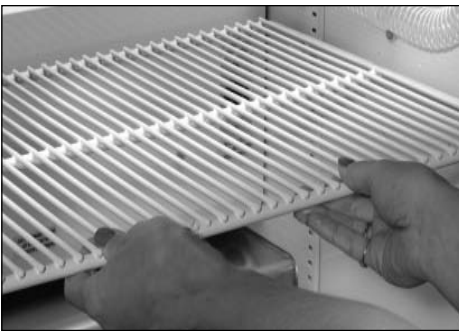

Figure 2.

4. Using needle-nosed pliers remove the right or left pilaster as needed. (This will provide clearance to pull right or left housing away from evaporator).

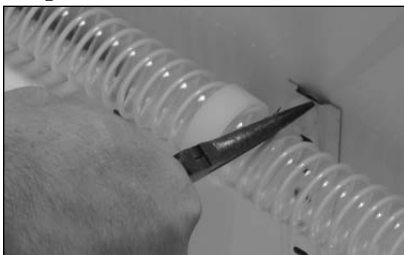

Figure 3.

5. Using a hex-head nut remover, remove right or left C-clamps as needed from chiller hose. (Remove clamps from both ends of the assembly).



Figure 4.

6. Back off four slotted thumb screws and remove evaporator housing.

**IMPORTANT:** Note the proper position of the flexible tubing on top of evaporator. (See Fig. 6). Hose will need to be repositioned in the same area to ensure proper conditioned air circulation.



Figure 5.

7. **CAUTION:** Gloves are recommended to avoid contact with possible sharp edges. Gently pull housing from the right or left side and work forward in order to access the flexible hose.

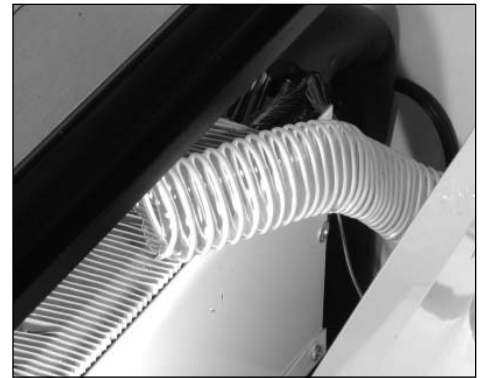

Figure 6.

8. Rout the bottle brush through the rear of the flexible hose and push contents forward.

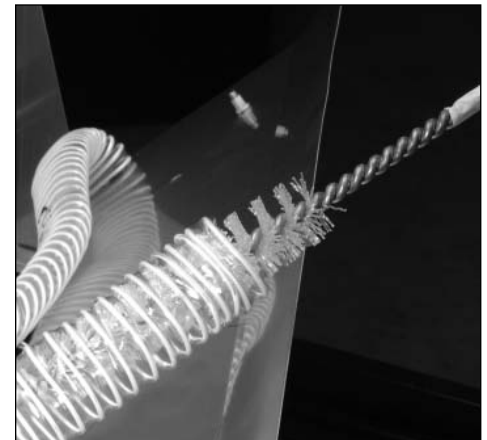

Figure 7.

9. Reverse the procedures as outlined above.

**NOTE:** Replace flexible hose in the original position as indicated in Fig. 6. Failure to replace properly will result in compromised unit operation.

INSTALLATION / OPERATION INSTRUCTIONS

**SHELVING INSTALLATION / OPERATION & LIGHT SWITCH LOCATION**

**WARNING**

Do not use pliers or any crimping tools when installing shelf clips. Altering shelf clips in any way can lead to shelving instability.

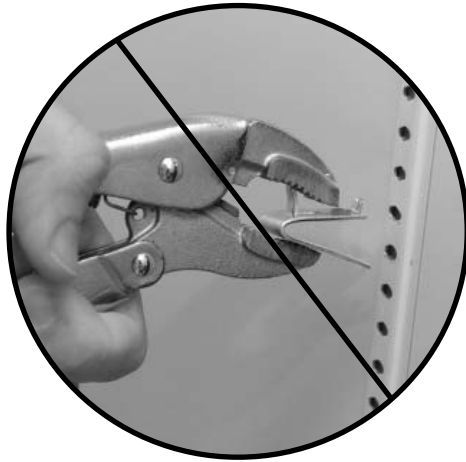

For Proper Shelf Clip Installation Please Read The Following Instructions.

**Step 1**

Shelf clips are to be installed into the shelf standards next to the labels on the interior cabinet wall. This label can be seen in images 1-4. Install the top tab of the shelf clip into the proper hole. Push up on the bottom of the clip. (See image 1).

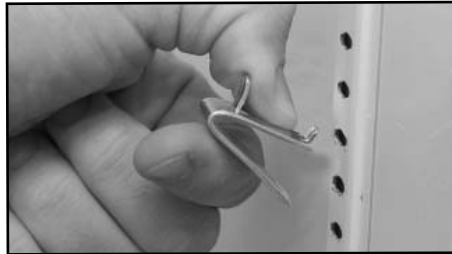

Image 1 (Installing top tab of shelf clip)

**Step 2**

Bottom tab of the shelf clip will fit tightly. You may need to squeeze or twist the bottom of the shelf clip to install. (See image 2 & 3).

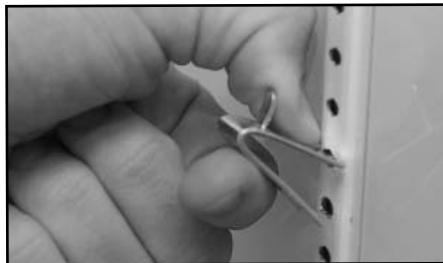

Image 2 (Installing bottom of the shelf clip)

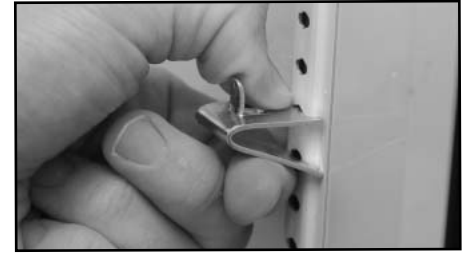

Image 3 (You may need to squeeze or twist the bottom of the shelf clip to install)



Image 4 (Shelf clip installation complete)

**Step 3**

After installation, the shelf clip will fit snug into the shelf standard. The shelf clip should not be loose or able to wiggle out of the shelf standard.

**Shelf Installation Tips**

1. Install all the shelf clips before installing the shelves.
2. Start at the bottom in terms of shelf installation and work your way up.
3. Always lay the back of each shelf down on the rear clips before the front.

**SHELF INSTALLATION:**

**Step 1**

- A. Hook shelf clips onto shelf standards. (see illustration).
- B. Position all four shelf clips equal in distance from the floor for flat shelves.

**WIRE SHELVES:**

Wire shelves are oriented so that cross support bars are facing down.

**Step 2**

Place shelves on shelf clips making sure all corners are seated properly.

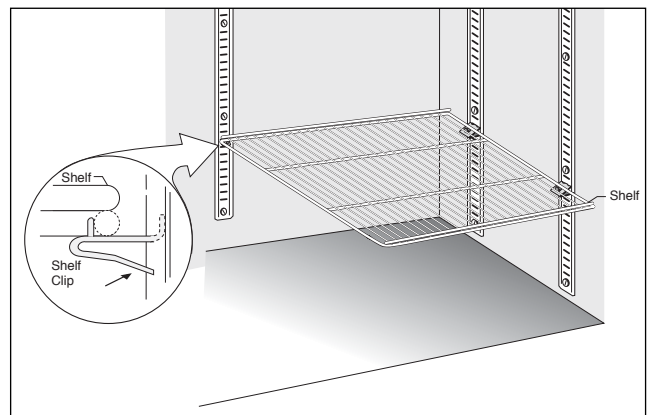

**LIGHT SWITCH LOCATION:**

Light switch location depends upon the TUC & TWT glass door model. Most models will have the light switch located inside the unit above the door. Most instances the switch is located next to the light on the ceiling.

MAINTENANCE, CARE & CLEANING

**MAINTENANCE, CARE & CLEANING**

**CLEANING THE CONDENSER COIL**

When using electrical appliances, basic safety precautions should be followed, including the following:

**REQUIRED TOOLS:**

- Phillips Screwdriver
- Stiff Bristle Brush
- Adjustable Wrench
- Vacuum Cleaner

**Step 1**

Disconnect power to unit.

**Step 2**

Remove the rear grill by backing out two screws.

(See image 3).

**Step 3**

Remove bolts anchoring compressor assembly to frame rails and carefully slide out. (tube connections are flexible)

**Step 4**

Clean off accumulated dirt from the condenser coil and the fan with a stiff bristle brush. (See image 1).

**Step 5**

Lift cardboard cover above fan at plastic plugs and carefully clean condenser coil and fan blades.

**Step 6**

After brushing condenser coil vacuum dirt from coil, and interior floor. (See image 2)

**Step 7**

Replace cardboard cover. Carefully slide compressor assembly back into position and replace bolts.

**Step 8**

Reinstall rear grill assembly onto unit. Tighten all screws.

**Step 9**

Connect unit to power and check to see if compressor is running.

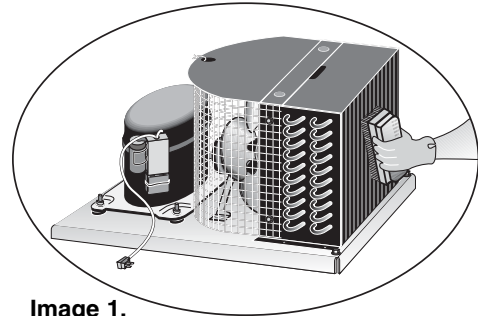

Image 1.

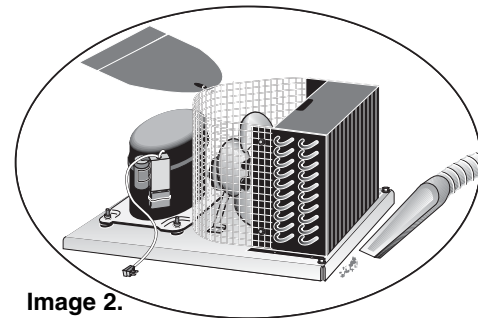

Image 2.

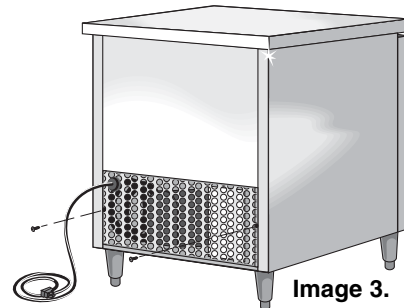

Image 3.

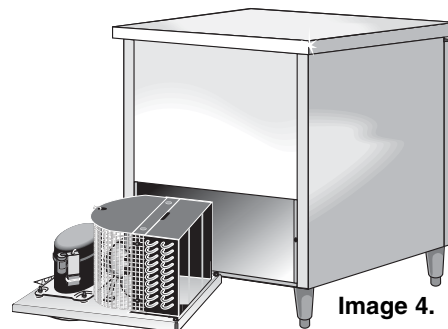

Image 4.

MAINTENANCE, CARE & CLEANING

**IMPORTANT WARRANTY INFORMATION**

**Condensers accumulate dirt and require cleaning every 30 days. Dirty condensers result in compressor failure, product loss, and lost sales... which are not covered by warranty.**

*If you keep the Condenser clean you will minimize your service expense and lower your electrical costs. The Condenser requires scheduled cleaning every thirty days or as needed.*

*Air is pulled through the Condenser continuously, along with dust, lint, grease, etc.*

*A dirty Condenser can result in NON-WARRANTED part & Compressor Failures, Product Loss, and Lost Sales.*

*Proper cleaning involves removing dust from the Condenser. By using a soft brush, or vacuuming the Condenser with a shop vac, or using CO2, nitrogen, or pressurized air.*

*If you cannot remove the dirt adequately, please call your refrigeration service company.*

*The Condenser looks like a group of vertical fins. You need to be able to see through the condenser for the unit to function at maximum capacity. Do not place filter material in front of condensing coil. This material blocks air-flow to the coil similar to having a dirty coil.*

**THE CLEANING OF THE CONDENSER IS NOT COVERED BY THE WARRANTY!**

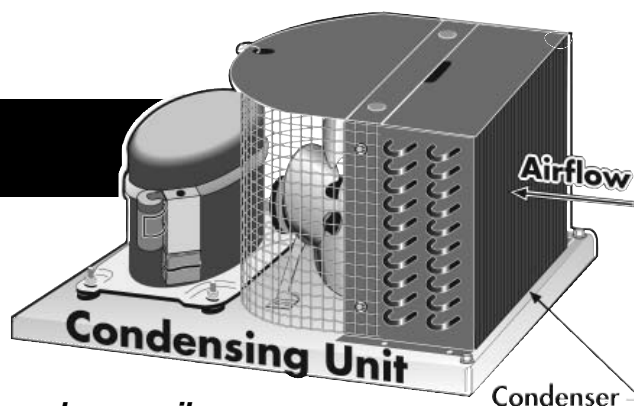

**HOW TO CLEAN THE CONDENSER:**

1. Disconnect the electrical power to the unit.
2. Remove the louvered grill.
3. Vacuum or brush the dirt, lint, or debris from the finned condenser coil.
4. If you have a significant dirt build up you can blow out the condenser with compressed air. (CAUTION MUST BE USED to avoid eye injury. Eye protection is recommended.)
5. When finished be sure to replace the louvered grill. The grill protects the condenser.
6. Reconnect the electrical power to the unit.

*If you have any questions, please call TRUE Manufacturing at 636-240-2400 or 800-325-6152 and ask for the Service Department. Service Department Availability Monday-Friday 7:30 a.m. to 5:30p.m. and Saturday 8:00 a.m. to 12:00 a.m. CST.*



## MAINTENANCE, CARE &amp; CLEANING

**Stainless Steel Equipment Care and Cleaning**

**CAUTION: Do not use any steel wool, abrasive or chlorine based products to clean stainless steel surfaces.**

- Stainless Steel Opponents

There are three basic things which can break down your stainless steel's passivity layer and allow corrosion to rear its ugly head.

- 1) Scratches from wire brushes, scrapers, and steel pads are just a few examples of items that can be abrasive to stainless steel's surface.
- 2) Deposits left on your stainless steel can leave spots. You may have hard or soft water depending on what part of the country you live in. Hard water can leave spots. Hard water that is heated can leave deposits if left to sit too long. These deposits can cause the passive layer to break down and rust your stainless steel. All deposits left from food prep or service should be removed as soon as possible.
- 3) Chlorides are present in table salt, food, and water. Household and industrial cleaners are the worst type of chlorides to use.

- 8 steps that can help prevent rust on stainless steel:

1. Using the correct cleaning tools

Use non-abrasive tools when cleaning your stainless steel products. The stainless steel's passive layer will not be harmed by soft cloths and plastic scouring pads. Step 2 tells you how to find the polishing marks.

2. Cleaning along the polish lines

Polishing lines or "grain" are visible on some stainless steels. Always scrub parallel to visible lines on some stainless steels. Use a plastic scouring pad or soft cloth when you cannot see the grain.

3. Use alkaline, alkaline chlorinated or non-chloride containing cleaners

While many traditional cleaners are loaded with chlorides, the industry is providing an ever increasing choice of non-chloride cleaners. If you are not sure of your cleaner's chloride content contact your cleaner supplier. If they tell you that your present cleaner contains chlorides, ask if they have an alternative. Avoid cleaners containing quaternary salts as they can attack stainless steel, causing pitting and rusting.

4. Water Treatment

To reduce deposits, soften the hard water when possible. Installation of certain filters can remove corrosive and distasteful elements. Salts in a properly maintained water softener can be to your advantage. Contact a treatment specialist if you are not sure of the proper water treatment.

5. Maintaining the cleanliness of your food equipment

Use cleaners at recommended strength (alkaline, alkaline chlorinated or non-chloride). Avoid build-up of hard stains by cleaning frequently. When boiling water with your stainless steel equipment, the single most likely cause of damage is chlorides in the water. Heating any cleaners containing chlorides will have the same damaging effects.

6. Rinse

When using chlorinated cleaners you must rinse and wipe dry immediately. It is better to wipe standing cleaning agents and water as soon as possible. Allow the stainless steel equipment to air dry. Oxygen helps maintain the passivity film on stainless steel.

7. Hydrochloric acid (muriatic acid) should never be used on stainless steel

8. Regularly restore/passivate stainless steel

## **Stainless Steel Equipment Care and Cleaning**

### **Recommended cleaners for certain situations / environments of stainless steel**

- A) Soap, ammonia and detergent medallion applied with a cloth or sponge can be used for routine cleaning.
- B) Arcal 20, Lac-O-Nu Ecoshine applied provides barrier film for fingerprints and smears.
- C) Cameo, Talc, Zud First Impression is applied by rubbing in the direction of the polished lines for stubborn stains and discoloring.
- D) Easy-off and De-Grease It oven aid are excellent for removals on all finishes for grease-fatty acids, blood and burnt-on foods.
- E) Any good commercial detergent can be applied with a sponge or cloth to remove grease and oil.
- F) Benefit, Super Sheen, Sheila Shine are good for restoration / passivation.

**NOTE:**

***The use of stainless steel cleaners or other such solvents is not recommended on plastic parts. Warm soap and water will suffice.***

## **Composite Cutting Board Maintenance**

Please see comments from Supplier regarding composite cutting boards below.

RE: Composite Cutting Boards Manufactured From Richlite Material and Warping.

“To prevent warping on cutting boards manufactured from Richlite® material, simply turn the board over on a regular scheduled basis. Warping is caused by continued moisture and temperature differences on the top and bottom of the boards. By turning the board over, this will allow both sides of the board to receive the same exposure.

There is a chance that larger size boards may warp as a characteristic of the material.”

MAINTENANCE, CARE & CLEANING

## Periodic Maintenance for Lids

**NOTE:** Because lid pin screws are designed to be removable for cleaning, it is important these are checked periodically to assure they are tight.

- Step 1

Check to see if lid assembly thumbscrews are tight. **See Image 1.**

**NOTE:** Check TSSU Model thumbscrews on the inside and outside. Check TPP model thumbscrews on the inside only.

- Step 2

Use slotted screwdriver to tighten thumbscrews into place. **See Image 2.**

- Step 3

Make sure that thumbscrews are secure.

TSSU Unit

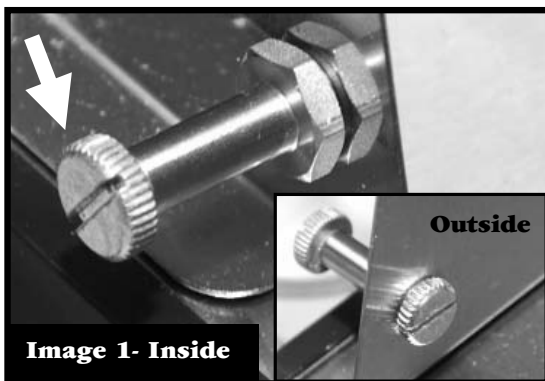

TPP Unit

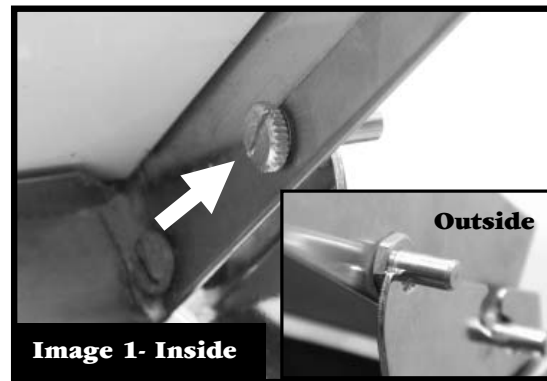



## WARRANTY INFORMATION (U.S.A & CANADA ONLY!)

### ONE YEAR PARTS & LABOR WARRANTY

TRUE warrants to the original purchaser of every new TRUE refrigerated unit, the cabinet and all parts thereof, to be free from defects in material or workmanship, under normal and proper use and maintenance service as specified by TRUE and upon proper installation and start-up in accordance with the instruction packet supplied with each TRUE unit. TRUE's obligation under this warranty is limited to a period of one (1) year from the date of original installation or 15 months after shipment date from TRUE, whichever occurs first.

Any part covered under this warranty that are determined by TRUE to have been defective within one (1) year of original installation or fifteen (15) months after shipment date from manufacturer, whichever occurs first, is limited to the repair or replacement, including labor charges, of defective parts or assemblies. The labor warranty shall include standard straight time labor charges only and reasonable travel time, as determined by TRUE.

### ADDITIONAL FOUR YEAR COMPRESSOR WARRANTY

In addition to the one (1) year warranty stated above, TRUE warrants its hermetically and semi-hermetically sealed compressor to be free from defects in both material and workmanship under normal and proper use and maintenance service for a period of four (4) additional years from the date of original installation but not to exceed five (5) years and three (3) months after shipment from the manufacturer.

Compressors determined by TRUE to have been defective within this extended time period will, at TRUE's option, be either repaired or replaced with a compressor or compressor parts of similar design and capacity.

The four (4) year extended compressor warranty applies only to hermetically and semi-hermetically sealed parts of the compressor and does not apply to any other parts or components, including, but not limited to, cabinet, paint finish, temperature control, refrigerant, metering device, driers, motor starting equipment, fan assembly or any other electrical component, etcetera.

### 404A/134A COMPRESSOR WARRANTY

The four year compressor warranty detailed above will be voided if the following procedure is not carefully adhered to:

1. This system contains R404A or R134A refrigerant and polyol ester lubricant. The polyol ester lubricant has rapid moisture absorbing qualities. If long exposure to the ambient conditions occur, the lubricant must be removed and replaced with new. For oil amounts and specifications please call True technical service department (800-325-6152). Failure to comply with recommended lubricant specification will void the compressor warranty.
2. Drier replacement is very important and must be changed when a system is opened for servicing. A drier using XH-7 desiccant or an exact replacement solid core drier must be used. The new drier must also be the same capacity as the drier being replaced.
3. Micron level vacuums must be achieved to insure low moisture levels in the system. 500 microns or lower must be obtained.

### WARRANTY CLAIMS

All claims for labor or parts must be made directly through TRUE. All claims should include: model number of the unit, the serial number of the cabinet, proof of purchase, date of installation, and all pertinent information supporting the existence of the alleged defect.

In case of warranty compressor, the compressor model tag must be returned to TRUE along with above listed information.

Any action or breach of these warranty provisions must be commenced within one (1) year after that cause of action has occurred.

### WHAT IS NOT COVERED BY THIS WARRANTY

TRUE's sole obligation under this warranty is limited to either repair or replacement of parts, subject to the additional limitations below. This warranty neither assumes nor authorizes any person to assume obligations other than those expressly covered by this warranty.

**NO CONSEQUENTIAL DAMAGES.** TRUE IS NOT RESPONSIBLE FOR ECONOMIC LOSS; PROFIT LOSS; OR SPECIAL, INDIRECT, OR CONSEQUENTIAL DAMAGES, INCLUDING WITHOUT LIMITATION, LOSSES OR DAMAGES ARISING FROM FOOD OR PRODUCT SPOILAGE CLAIMS WHETHER OR NOT ON ACCOUNT OF REFRIGERATION FAILURE.

**WARRANTY IS NOT TRANSFERABLE.** This warranty is not assignable and applies only in favor of the original purchaser/user to whom delivered. ANY SUCH ASSIGNMENT OR TRANSFER SHALL VOID THE WARRANTIES HEREIN MADE AND SHALL VOID ALL WARRANTIES, EXPRESS OR IMPLIED, INCLUDING ANY WARRANTY OF MERCHANTABILITY OR FITNESS FOR A PARTICULAR PURPOSE.

**IMPROPER USAGE.** TRUE ASSUMES NO LIABILITY FOR PARTS OR LABOR COVERAGE FOR COMPONENT FAILURE OR OTHER DAMAGES RESULTING FROM IMPROPER USAGE OR INSTALLATION OR FAILURE TO CLEAN AND/OR MAINTAIN PRODUCT AS SET FORTH IN THE WARRANTY PACKET PROVIDED WITH THE UNIT.

**RESIDENTIAL APPLICATIONS:** True assumes no liability for parts or labor coverage for component failure or other damages resulting from installation in non-commercial or residential applications.

**ALTERATION, NEGLIGENCE, ABUSE, MISUSE, ACCIDENT, DAMAGE DURING TRANSIT OR INSTALLATION, FIRE, FLOOD, ACTS OF GOD.** TRUE is not responsible for the repair or replacement of any parts that TRUE determines have been subjected after the date of manufacture to alteration, neglect, abuse, misuse, accident, damage during transit or installation, fire, flood, or act of God.

**IMPROPER ELECTRICAL CONNECTIONS.** TRUE IS NOT RESPONSIBLE FOR THE REPAIR OR REPLACEMENT OF FAILED OR DAMAGED COMPONENTS RESULTING FROM ELECTRICAL POWER FAILURE, THE USE OF EXTENSION CORDS, LOW VOLTAGE, OR VOLTAGE DROPS TO THE UNIT.

**NO IMPLIED WARRANTY OF MERCHANTABILITY OR FITNESS FOR A PARTICULAR PURPOSE:** THERE ARE NO OTHER WARRANTIES, EXPRESSED, IMPLIED OR STATUTORY, EXCEPT THE ONE (1) YEAR PARTS & LABOR WARRANTY AND THE ADDITIONAL FOUR (4) YEAR COMPRESSOR WARRANTY AS DESCRIBED ABOVE. THESE WARRANTIES ARE EXCLUSIVE AND IN LIEU OF ALL OTHER WARRANTIES, INCLUDING IMPLIED WARRANTY AND MERCHANTABILITY OR FITNESS FOR A PARTICULAR PURPOSE. THERE ARE NO WARRANTIES WHICH EXTEND BEYOND THE DESCRIPTION ON THE FACE HEREOF.

**OUTSIDE U.S./Canada:** This warranty does not apply to, and TRUE is not responsible for, any warranty claims made on products sold or used outside the United States or Canada.