

## INSTALLATION MANUAL FOR T-SERIES FREEZER / REFRIGERATOR (SWING AND SLIDE DOOR)

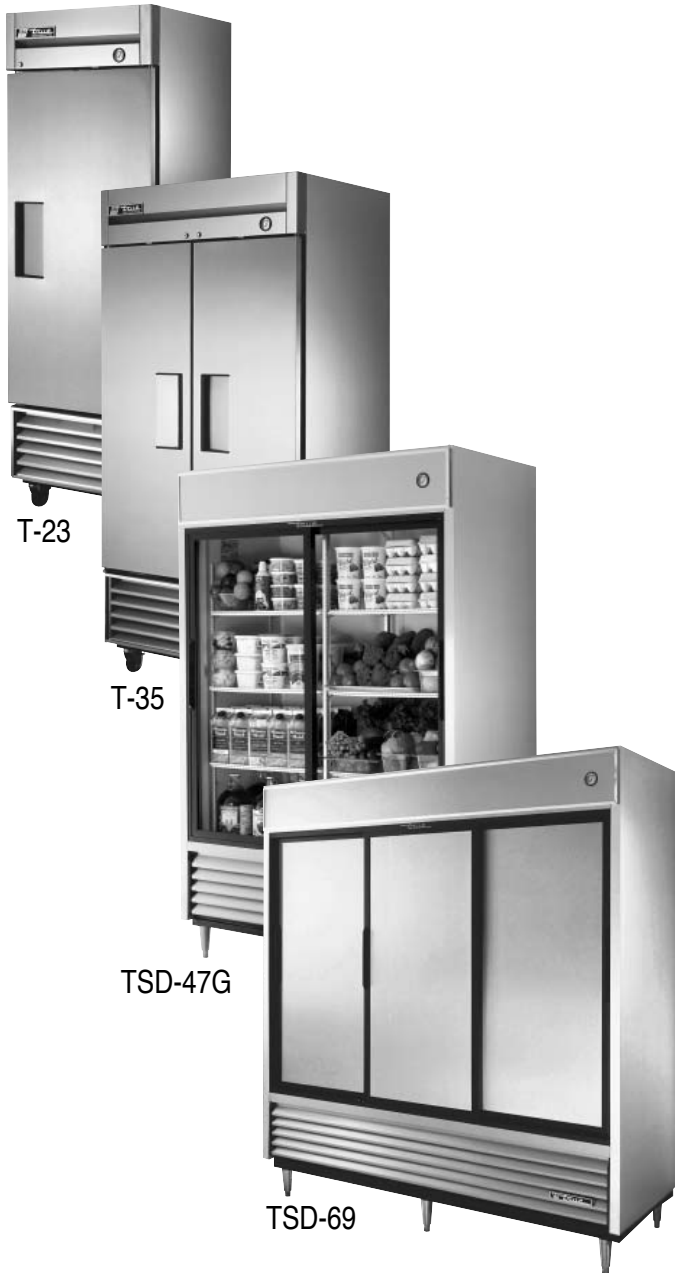

### TABLE OF CONTENTS

#### ► **Safety Information**

Safety Precautions	1
TSD Do's and Don'ts	2
Proper Disposal	3
Connecting Electricity	4
Adapter Plugs	4

#### ► **Installation / Operation Instructions**

Ownership	5
Required Tools	5
Uncrating	5
Leveling Cabinet	6
Installation of Castors or Optional Legs	7
Installing Optional Castors on a T-12FG	8
Slide Door Operation Instructions	9
Wire Gauge Chart	10
Sealing Cabinet to Floor & Electrical Inst.	11
Start-up	12
Shelving Install/Operation & Light Switches	13
Grasslin Defrost Timer (Freezer Units Only)	14
Field Troubleshooting (Freezer Units Only)	15-16
Light Cover Install for T-12FG	17

#### ► **Maintenance, Care & Cleaning**

Cleaning Condenser Coil	18-19
Temperature Control Adjustment	20
Stainless Steel Equipment Care & Cleaning	21-22
Light Bulb Replacement	22
Warranty (U.S.A. & CANADA ONLY!)	23

\*Spanish, German, French, Dutch, and Arabic versions included.

### CONGRATULATIONS!

*You have just purchased the finest commercial freezer / refrigerator available. You can expect many years of trouble-free operation.*

# T-SERIES FREEZER / REFRIGERATOR SWING & SLIDE DOOR

# **NOTICE TO CUSTOMER:**



**Loss Or Spoilage Of Products  
In Your Refrigerator/Freezer  
Is NOT Covered By Warranty.  
In Addition To Following  
Recommended Installation  
Procedures You Must Run  
The Refrigerator/Freezer  
24 Hours Prior To Usage.**

True Manufacturing Company, Inc.

SAFETY INFORMATION

# **How to Maintain Your *TRUE*® Freezer / Refrigerator to Receive the Most Efficient and Successful Operation**

*You have selected one of the finest commercial refrigeration units made. It is manufactured under strict quality controls with only the best quality materials available. Your TRUE cooler when properly maintained will give you many years of trouble-free service.*

## **WARNING!**

*Use this appliance for its intended purpose as described in this Owner Manual.*

***This cabinet contains fluorinated greenhouse gas covered by the Kyoto Protocol (please refer to cabinet's inner label for type and volume, GWP of 134a= 1,300. R404a= 3,800).***

## **SAFETY PRECAUTIONS**

*When using electrical appliances, basic safety precautions should be followed, including the following:*

- This refrigerator must be properly installed and located in accordance with the Installation Instructions before it is used.
- Do not allow children to climb, stand or hang on the shelves in the refrigerator. They could damage the refrigerator and seriously injure themselves.
- Do not touch the cold surfaces in the freezer compartment when hands are damp or wet. Skin may stick to these extremely cold surfaces.
- Do not store or use gasoline or other flammable vapors and liquids in the vicinity of this or any other appliance.
- Keep fingers out of the "pinch point" areas; clearances between the doors and between the doors and cabinet are necessarily small; be careful closing doors when children are in the area.

**NOTE:** *We strongly recommend that any servicing be performed by a qualified individual.*

- Unplug the refrigerator before cleaning and making repairs.
- Setting temperature controls to the 0 position does not remove power to the light circuit, perimeter heaters, or evaporator fans.

### TSD Installation and Maintenance Do's and Don'ts

**1** Once cooler is in final location, cooler should be levelled front to back and side to side.

**2** Turn castors or leg levellers counter clockwise as necessary in order to properly level cooler. Add shims if castors are backed out for leveling.

**3** Remove three plastic door blocks (slide door units) from above and below doors. On swing door units remove metal door block attached to the bottom of doors. If the doors do not completely slide shut, follow steps 1 & 2 until the cooler is level.

**4** Never use an extension cord! Using extension cords voids warranty!

**5** Never plug in more than one unit per electrical circuit.

**6** With use of a cotton swab (or brush), put a small amount of grease into bearing part of roller. Turn wheel several times to lubricate entire bearing.

**7** Use only silicone spray to lubricate the door weight cord. Use a rag to clean out slide door v-tracks

**8** Allow sufficient space between wall and/or another cooler for air circulation.

**9** The temperature control should always be set no higher than number 5 for maximum efficiency.

**10** Do not stand or place feet on the door channels.

**11** When loading top shelf of cooler, do not block evaporator fan. Allow at least 4" space between the fan and product.

**12** Condenser should be kept clean by vacuuming, brushing with a stiff bristle brush or using compressed air to remove dust and debris.

SAFETY INFORMATION

**DANGER!**  
**RISK OF CHILD ENTRAPMENT**

**PROPER DISPOSAL OF THE FREEZER / REFRIGERATOR**

---

Child entrapment and suffocation are not problems of the past. Junked or abandoned refrigerators are still dangerous... even if they will sit for “just a few days.” If you are getting rid of your old refrigerator, please follow the instructions below to help prevent accidents.

**Before You Throw Away Your Old Refrigerator or Freezer:**

- Take off the doors.
- Leave the shelves in place so that children may not easily climb inside.

**Refrigerant Disposal**

Your old refrigerator may have a cooling system that uses “Ozone Depleting ” chemicals. If you are throwing away your old refrigerator, make sure the refrigerant is removed for proper disposal by a qualified service technician. If you intentionally release any refrigerants you can be subject to fines and imprisonment under provisions of the environmental regulations.

**USE OF EXTENSION CORDS**

---

*NEVER USE AN EXTENSION CORD! TRUE will not warranty any refrigerator that has been connected to an extension cord.*

SAFETY INFORMATION

# WARNING!

## HOW TO CONNECT ELECTRICITY

Do not, under any circumstances, cut or remove the third (ground) prong from the power cord. For personal safety, this appliance must be properly grounded.

The power cord of this appliance is equipped with a 3-prong (grounding) plug which mates with a standard 3-prong (grounding) wall outlet to minimize the possibility of electric shock hazard from this appliance.

Have the wall outlet and circuit checked by a qualified electrician to make sure the outlet is properly grounded.

If the outlet is a standard 2-prong outlet, it is your personal responsibility and obligation to have it replaced with the properly grounded 3-prong wall outlet.

The refrigerator should always be plugged into it's own individual electrical circuit, which has a voltage rating that matches the rating plate.

This provides the best performance and also prevents overloading building wiring circuits which could cause a fire hazard from overheated wires.

Never unplug your refrigerator by pulling on the power cord. Always grip plug firmly and pull straight out from the outlet.

Repair or replace immediately all power cords that have become frayed or otherwise damaged. Do not use a cord that shows cracks or abrasion damage along its length or at either end.

When removing the refrigerator away from the wall, be careful not to roll over or damage the power cord.

## USE OF ADAPTER PLUGS

NEVER USE AN ADAPTER PLUG! Because of potential safety hazards under certain conditions, we strongly recommend against the use of an adapter plug.

**(North America Use Only!)**

NEMA plugs

TRUE uses these types of plugs. If you do not have the right outlet have a certified electrician install the correct power source.



## T-72F WIRING CHANGES (110V Application Only)

Previous design: 4 prong plug NEMA 14-20R - 4 wire circuit (see image 1).

Current design: 3 prong plug NEMA 5-20R - 3 wire circuit (see image 2).

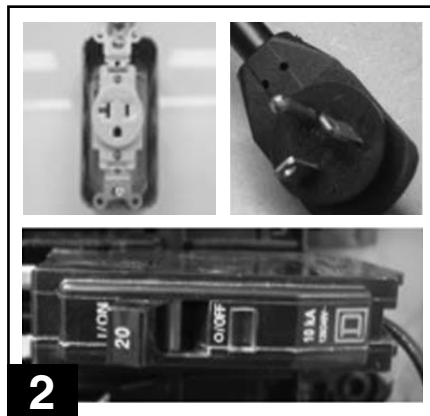
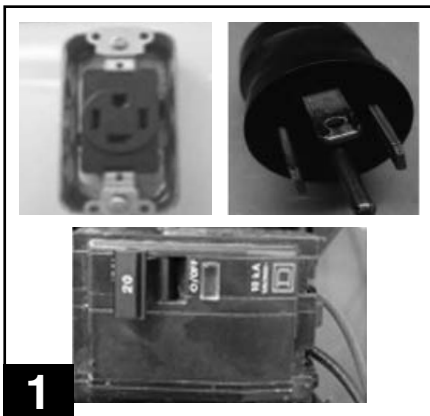

### WIRING CONVERSION

**At Receptacle Box**

1. Turn breaker off
2. Disconnect all wires from receptacle
3. Insulate red wire (tape or wire nut)
4. Connect black, white, and green wires to 3 prong plug NEMA 5-20R per instructions on receptacle

**At Breaker Panel**

1. With breaker turned off, remove wires
2. Remove double pole breaker
3. Install single pole breaker
4. Connect black wire to breaker
5. Insulate red wire
6. Turn breaker back on

**NOTE:** It is the customer's responsibility to make sure receptacle wiring meets all local electrical codes. TRUE recommends hiring a licensed qualified electrician to make this change.

INSTALLATION / OPERATION INSTRUCTIONS

**INSTALLATION / OPERATION INSTRUCTIONS**  
**OWNERSHIP**

To insure that your unit works properly from the first day, it must be installed properly. We highly recommend a trained refrigeration mechanic and electrician install your **True** equipment. The cost of a professional installation is money well spent.

Before you start to install your **True** unit, carefully inspect it for freight damage. If damage is discovered, immediately file a claim with the delivery freight carrier.

**True is not responsible for damage incurred during shipment.**

**REQUIRED TOOLS**

- Adjustable Wrench
- Phillips Head Screwdriver
- Level

**UNCRATING**

**NOTE:**

*Units with a solar thermometer will experience a 15 second delay after exposed to light before it reads the proper temperature.*

The following procedure is recommended for uncrating the unit:

- A.** Remove the outer packaging, (cardboard and bubbles or styrofoam corners and clear plastic). Inspect for concealed damage. Again, immediately file a claim with the freight carrier if there is damage.
- B.** Move your unit as close to the final location as possible before removing the wooden skid.

- C.** Remove door bracket on swinging glass door models (see image 1-2). Sliding glass door models contain shipping blocks (three for each door). Remove the two styrofoam blocks taped to the top of the door tracks (see image 3). The shipping blocks are orange in color and by opening the door a little the blocks can be removed (see images 4-6). Do not throw the bracket or blocks away. For future cabinet movement the bracket and blocks will need to be installed so the glass door does not receive any damage. (See image for bracket and shipping block removal)

**Note:** Keys for coolers with door locks are located in warranty packets.

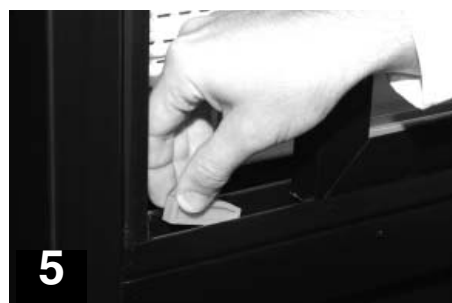

INSTALLATION / OPERATION INSTRUCTIONS

**LOCATING**

- A. Remove louver from the front of cabinet (see page 17 for louver grill removal / reinstallation) and backguard (if applicable) from rear of cabinet.
- B. Skid bolts are located in each of 4 corners inside cabinet bottom. (See photo A).
- C. Remove skid bolts. (See photo B).
- D. Cut straps if applicable. (See photo C).
- E. Carefully lift cabinet off of skid.

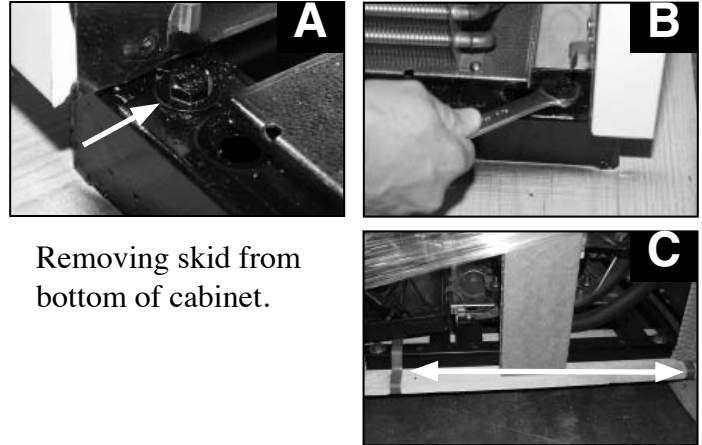

Removing skid from bottom of cabinet.

**LEVELING**

- A. Set unit in its final location. Be sure there is adequate ventilation in your room. Under extreme heat conditions, (100°F+, 38°C+), you may want to install an exhaust fan.

**Warning**

*Warranty is void if ventilation is insufficient.*

- B. Proper leveling of your True cooler is critical to operating success (for non-mobile models). Effective condensate removal and door operation will be effected by leveling.
- C. The cooler should be leveled front to back and side to side with a level.
- D. Ensure that the drain hose or hoses are positioned in the pan.
- E. Free plug and cord from inside the lower rear of the cooler (do not plug in).
- F. The unit should be placed close enough to the electrical supply so that extension cords are never used.

**Warning**

*Compressor warranties are void if the unit is more than 7 ft. (2.1m) from plug-in connection.*

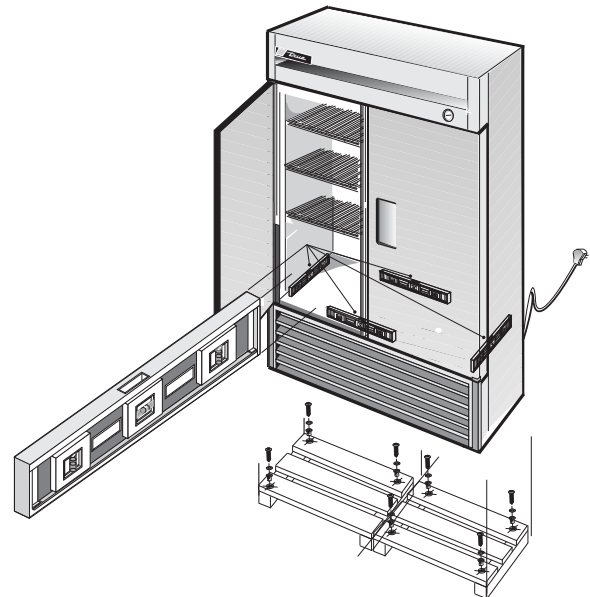

**REMOTE UNITS (This section applies to remotes only!)**

- Remote cabinets must be ordered as remote. We do not recommend converting from a standard self contained to remote system.
- All remote cabinets must be hard wired.
- No castors available.
- All remote cabinets come standard using 404A refrigerant.
- All remote units come standard with expansion valve, liquid line solenoid, heated condensate pan, and defrost timer when applicable.

- Contact True Technical Service for BTU requirements.
- No wiring necessary between cabinet and condensing unit.
- All remote condensing units purchased from True are 208/230 volts single phase.

**If you have any questions regarding this section, please call True at 1-(800)-325-6152.**



INSTALLATION / OPERATION INSTRUCTIONS

**INSTALLATION OF CASTORS OR OPTIONAL LEGS**

Important Safeguard for installation of leg/castor (Images 1-5 demonstrate procedure)

**Securing Castors and Legs**

To obtain maximum strength and stability of the unit, it is important that you make sure each castor is secure. Optional legs are hand-tightened securely against the lower rail assembly see image 4-5. The bearing race on the castor or the top edge of the leg must make firm contact with the rail.

**Unit leveling**

Four leveling shims have been provided for leveling castored units positioned on uneven floors. Shims must be positioned between rail end and bearing race.

**A.** Turn the bearing race counter-clockwise until the cabinet is level. Level front to back and side to side. (diagonally)

**B.** Install the desired number of shims, making sure the slot of the shim is in contact with the threaded stem of the castor. (See image 2)

**C.** If more than one shim is used, turn the slot at a 90° angle so they are not in line.

**D.** Turn the bearing race clockwise to tighten and secure the castor by tightening the anchoring bolt with a 3/4 inch open-end wrench or the tool provided. (See image 3)

**CAUTION**

**To avoid damage to lower rail assembly, slowly raise unit to upright position.**

Note: Open holes located on the cross members of the frame rail should be plugged before unit is in use.



1 Thread castor into the underside of cabinet frame rail.



2 For leveling, insert the shim between the castor and frame rail.



3 Use the tool provided to tighten the castor into place.



4 Thread leg into cabinet bottom frame rail.



5 The end of the leg is adjustable to easy leveling.

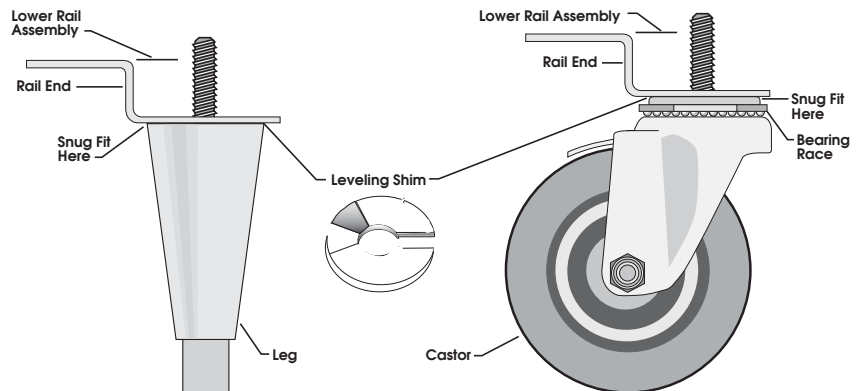

INSTALLATION / OPERATION INSTRUCTIONS

**INSTALLING OPTIONAL CASTORS ON A T-12FG**

**Final Location**

- A.** Place styrofoam corners behind cooler for cushion and carefully tilt unit on it's back.
  - B.** Remove the louvered grill by removing four phillips-head screws.
  - C.** Remove the four bolts from the skid with an adjustable wrench, and locate the four castors. Castors are placed inside cooler, within the bubble wrap.
  - D.** Install one castor in each of the four female threaded areas as indicated.
- NOTE: Two out of the four castors are designated with an "F" for front. These are provided with hand-brakes. Position these castors in FRONT of the unit.**
- E.** When all castors have been threaded fully, replace grill and lift unit; positioning it into its final location.
  - F.** Ensure that the two front castors are positioned FORWARD as illustrated and locked down with the hand-brakes.

**WARNING:**

**Unit may tip forward if procedure "F" is not strictly followed.**

- G.** Units final location should be adequately ventilated. Conditions where heat exceeds 100°F require an exhaust fan.
- H.** Ensure that the drain hose for hoses are positioned in the pan.
- I.** Free plug and cord from inside the lower rear of the cooler (Do Not Plug In.)

**WARNING:**

**Warranty is VOID if ventilation is insufficient.**

- J.** The unit should be placed close enough to the electrical supply so that extension cords are NEVER used.

**WARNING:**

**Compressor warranties are void if the unit is more than 6 1/2ft. (1.98m) from plug-in connection.**

- K.** Proper leveling of your TRUE cooler is critical to operating success. Effective condensate removal and door operation will be effected by leveling. Adjust castors or add shims.

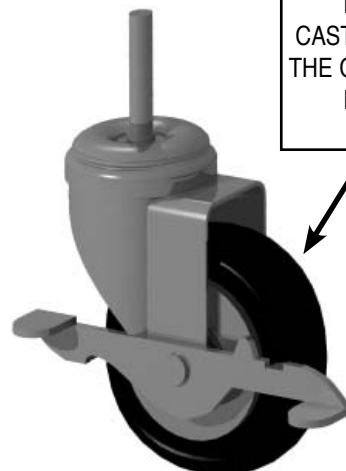

POSITIONING OF THE CASTOR IS CRITICAL. ORIENT THE CASTOR IN THE FORWARD POSITION AS SHOWN

INSTALLATION / OPERATION INSTRUCTIONS

**SLIDE DOORS**

**STEP 1**

Before removing slide door do not use the side latch. Tension on the door cord is needed to execute these operation instructions. Doors can not be removed unless placed in specific locations stated in these instructions.

**STEP 2**

**Two Door Units:** Slide the front door so it is centered on the cabinet. The door can not be removed unless it is centered. See image 1 for door channel openings and image 2 for centering door.

**Three Door Units:** Slide the middle door to the right side so the glass is centered with the left edge of the right side door. See image 3.



Image 1 (Two Door Units ONLY)



Image 2 (Two Door Units ONLY)



Image 3 (Three Door Units ONLY)

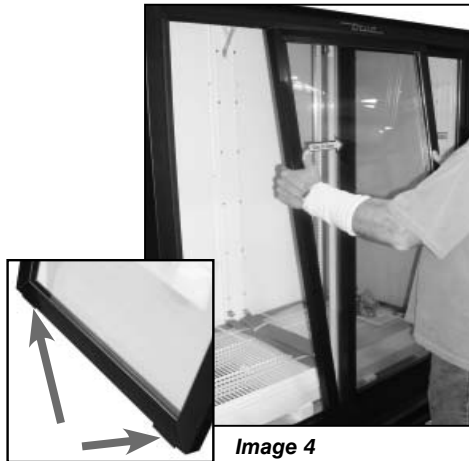

Image 4

**Gasket fasten to door bottom assures door will remain in track when unit is placed on uneven surface.**

**STEP 3**

After centering the door lift it up and tilt top of door towards the back of the unit so the rollers are out of the top channel. Swing the bottom of the door out of the bottom channel. Then remove the door and set it down. See image 4.

**(TWO DOOR UNITS SKIP TO STEP 6)**

**STEP 4**

Slide right door to the left so left edge lines up with the left edge of True Logo located above the door. See image 5. Then lift door out of track same way as image 4.

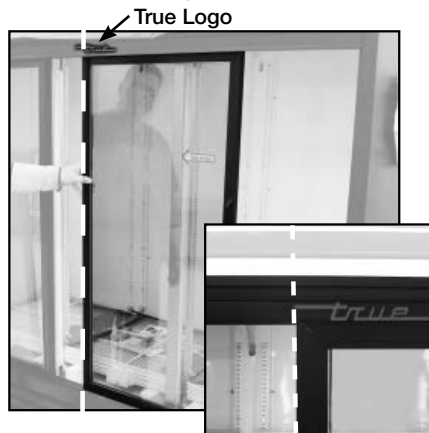

Image 5 (Three Door Units ONLY)

**STEP 5**

Slide left door to the right so right edge lines up with the end of the True Logo located at the top of the door frame. See image 6. Then lift door out of track same way as image 4.

**STEP 6**

Remove door cord from roller bracket. The black plastic tab holding the door cord slides out the back. See images 7 & 8.

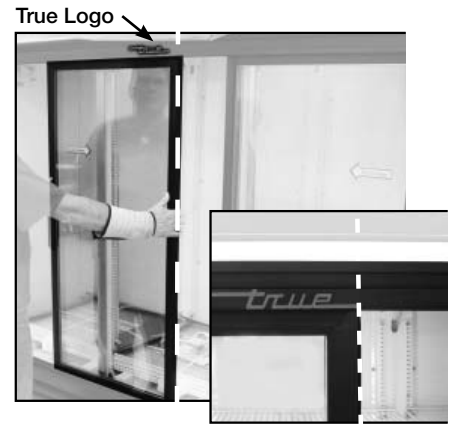

Image 6 (Three Door Units ONLY)



Image 7



Image 8

**STEP 7**

Let the door cord slowly retract back into the door side channel. The knot tied at the end of the door cord will keep the cord from retracting all the way back into the door channel. See image 9.

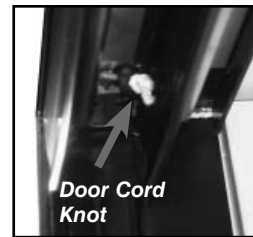
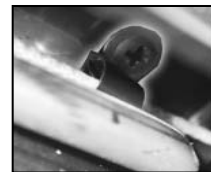

Image 9



**P-Clip keeps cord in-place (prevents cord damage).**

**TO ADJUST SLIDE DOOR**

**STEP 1**

After cabinet is installed in a final location and correctly leveled check for any openings when the slide doors are completely closed. If there are any gaps/openings between the closed doors and cabinet, the doors will need to be adjusted.

**STEP 2**

Using a 7/16" wrench or adjustable wrench and 1/8" allen wrench loosen roller and move along slotted hole. After adjustment has been made tighten the roller into place. See image 10.



Image 10

INSTALLATION / OPERATION INSTRUCTIONS

**CONDUCTORS AND CIRCUITS**

**Wire Gauge for 2% Voltage Drop in Supply Circuits**

115 Volt Amps	<i>Distance In Feet To Center of Load</i>											
	20	30	40	50	60	70	80	90	100	120	140	160
2	14	14	14	14	14	14	14	14	14	14	14	14
3	14	14	14	14	14	14	14	14	14	14	14	12
4	14	14	14	14	14	14	14	14	14	12	12	10
5	14	14	14	14	14	14	14	12	12	12	10	10
6	14	14	14	14	14	14	12	12	12	10	10	10
7	14	14	14	14	14	12	12	12	10	10	10	8
8	14	14	14	14	12	12	12	10	10	10	8	8
9	14	14	14	12	12	12	10	10	10	8	8	8
10	14	14	14	12	12	10	10	10	10	8	8	8
12	14	14	12	12	10	10	10	8	8	8	8	6
14	14	14	12	10	10	10	8	8	8	6	6	6
16	14	12	12	10	10	8	8	8	8	6	6	6
18	14	12	10	10	8	8	8	8	8	6	5	5
20	14	12	10	10	8	8	8	6	6	6	5	5
25	12	10	10	8	8	6	6	6	6	5	4	4
30	12	10	8	8	6	6	6	6	5	4	4	3
35	10	10	8	6	6	6	5	5	4	4	3	2
40	10	8	8	6	6	5	5	4	4	3	2	2
45	10	8	6	6	6	5	4	4	3	3	2	1
50	10	8	6	6	5	4	4	3	3	2	1	1

**Wire Gauge for 2% Voltage Drop in Supply Circuits**

230 Volts Amps	<i>Distance In Feet To Center of Load</i>											
	20	30	40	50	60	70	80	90	100	120	140	160
5	14	14	14	14	14	14	14	14	14	14	14	14
6	14	14	14	14	14	14	14	14	14	14	14	12
7	14	14	14	14	14	14	14	14	14	14	12	12
8	14	14	14	14	14	14	14	14	14	12	12	12
9	14	14	14	14	14	14	14	14	12	12	12	10
10	14	14	14	14	14	14	14	12	12	12	10	10
12	14	14	14	14	14	14	12	12	12	10	10	10
14	14	14	14	14	14	12	12	12	10	10	10	8
16	14	14	14	14	12	12	12	10	10	10	8	8
18	14	14	14	12	12	12	10	10	10	8	8	8
20	14	14	14	12	10	10	10	10	10	8	8	8
25	14	14	12	12	10	10	10	10	8	8	6	6
30	14	12	12	10	10	10	8	8	8	6	6	6
35	14	12	10	10	10	8	8	8	8	6	6	5
40	14	12	10	10	8	8	8	6	6	6	5	5
50	12	10	10	8	6	6	6	6	6	5	4	4
60	12	10	8	6	6	6	6	6	5	4	4	3
70	10	10	8	6	6	6	5	5	4	4	2	2
80	10	8	8	6	6	5	5	4	4	3	2	2
90	10	8	6	6	5	5	4	4	3	3	1	1
100	10	8	6	6	5	4	4	3	3	2	1	1

## **ELECTRICAL INSTRUCTIONS**

- A.** Before your new unit is connected to a power supply, check the incoming voltage with a voltmeter. If anything less than 100% of the rated voltage for operation is noted, correct immediately.
- B.** All units are equipped with a 7 ft. (2.1m) service cord, and must be powered at proper operating voltage at all times. Refer to cabinet data plate for this voltage.

**True** requires that a sole use circuit be dedicated for the unit. Failure to do so voids warranty.

### **WARNING**

Compressor warranties are void if compressor burns out due to low voltage.

### **WARNING**

Power supply cord ground should not be removed!

### **NOTE**

To reference wiring diagram - Remove front louvered grill, wiring diagram is positioned on the inside cabinet wall.

## **SEALING CABINET TO FLOOR**

### **Step 1 - Position Cabinet**

Allow one inch between the wall and rear of the refrigerator to assure proper ventilation. For freezers 3 inches between the wall and rear of the cabinet will assure proper ventilation.

### **Step 2 - Level Cabinet**

Cabinet should be level, side to side and front to back. Place a carpenter's level in the interior floor in four places:

- A.** Position level in the inside floor of the unit near the doors. (Level should be parallel to cabinet front). Level cabinet.
- B.** Position level at the inside rear of cabinet. (Again level should be placed parallel to cabinet back).
- C.** Perform similar procedures to steps a & b by placing the level on inside floor (left and right sides - parallel to the depth of the cooler). Level cabinet.

### **Step 3**

Draw an outline on the base on the floor.

### **Step 4**

Raise and block the front side of the cabinet.

### **Step 5**

Apply a bead of "NSF Approved Sealant", (see list below), To floor on half inch inside the outline

drawn. The bead must be heavy enough to seal the entire cabinet surface when it is down on the sealant.

### **Step 6**

Raise and block the rear of the cabinet

### **Step 7**

Apply sealant on floor as outline in Step 5. on other three sides.

### **Step 8**

Examine to see that cabinet is sealed to floor around entire perimeter.

### **Note:**

Asphalt floors are very susceptible to chemical attack. A layer of tape on the floor prior to applying the sealant will protect the floor.

### **NSF Approved Sealants:**

1. Minnesota Mining #ECU800 Caulk
2. Minnesota Mining #ECU2185 Caulk
3. Minnesota Mining #ECU1055 Bead
4. Minnesota Mining #ECU1202 Bead
5. Armstrong Cork - Rubber Caulk
6. Products Research Co. #5000 Rubber Caulk
7. G.E. Silicone Sealer
8. Dow Corning Silicone Sealer

## INSTALLATION / OPERATION INSTRUCTIONS

**FREEZERS ONLY! (COMPRESSOR BAND REMOVAL)****PLEASE CHECK YOUR COMPRESSOR. IF THERE IS A SHIPPING BAND, PLEASE REMOVE.****WARNING:****COMPRESSOR BAND MUST BE REMOVED BEFORE UNIT IS CONNECTED TO POWER SUPPLY.**

The metal band can be reached from the rear of the unit. A pair of tin snips will cut through the band. Once the band is located and removed. You may proceed with the installation of your new equipment. (See image to the right).



Cutting band that is around compressor

**STARTUP**

- A.** The compressor is ready to operate. Plug in the cooler.
- B.** Temperature control set at No. 4 position gives refrigerators an approximate temperature of 35°F. Allow unit to function several hours, completely cooling cabinet before changing the control setting.
- C.** Excessive tampering with the control could lead to service difficulties. Should it ever become necessary to replace temperature control, be sure it is ordered from your True dealer or recommended service agent.
- D.** Good air flow in your True unit is critical. Be careful to load product so that it neither presses against the back wall, nor comes within four inches of the evaporator housing. Refrigerated air off the coil must circulate down the back wall.

**NOTE**

*If the cooler is disconnected or shut off, wait five minutes before starting again.*

**RECOMMENDATION**

*Before loading product we recommend you run your True unit empty for two to three days. This allows you to be sure electrical wiring and installation are correct and no shipping damage has occurred. Remember, our factory warranty does not cover product loss!*

**REPLACEMENT PARTS**

*TRUE maintains a record of the cabinet serial number for your cooler. If at any time during the life of your cooler, a part is needed, you may obtain this part by furnishing the model number and serial number to the company from whom you purchased the cooler. Call Toll-Free: (800)-424-TRUE (Direct to Parts Department). (800)-325-6152 (U.S.A. & Canada only) or call: (636)-240-2400.*

## SHELVING INSTALLATION / OPERATION & LIGHT SWITCH LOCATION

### SHELF & ORGANIZER INSTALLATION:

#### Step 1

- A. Hook shelf clips onto shelf standards.  
(see illustration).
- B. Position all four shelf clips equal in distance from the floor for flat shelves.

### WIRE SHELVES:

Wire shelves are oriented so that cross support bars are facing down.

#### NOTE:

T-Series models include an airflow guard on the rear of shelves to maintain an air space at the rear of the cabinet. (see illustration).

#### Step 2

Place shelves on shelf clips making sure all corners are seated properly.

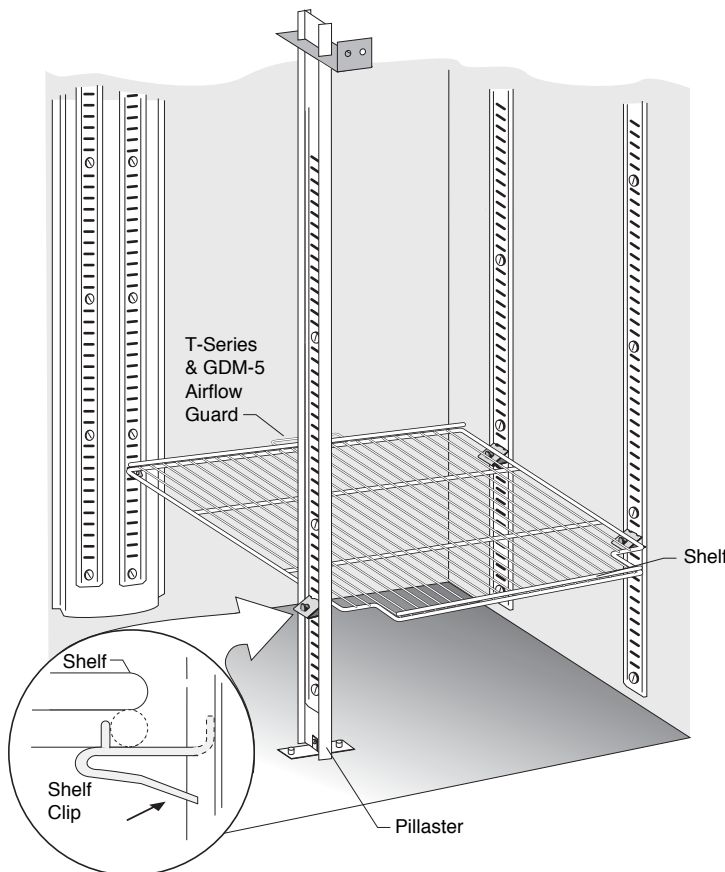

### LIGHT SWITCH LOCATION:

Light switch location depends upon the T-Series model. Most T-Series models will have the light switch located inside the unit on the right side of the ceiling. Most instances the switch is located next to the temperature control. Some models have the switch located on the right side of the evaporator housing along the interior ceiling.

INSTALLATION / OPERATION INSTRUCTIONS

**FREEZERS DEFROST TIME CLOCK OPERATION**

**T-19F, T-19FZ, T-23F  
Defrost System!**

*This defrost system is time initiated / time terminated. The refrigeration system does not restart until the defrost cycle has timed out.*

**REQUIRED TOOLS:**

- Phillips Screwdriver
- 1/4" Nut Driver or Socket

**Locating The Defrost Timer:**

See page 2 for removing louver grill instructions.

**\* T-23F-2 / T-23DT Grill must be reattached correctly for proper operation.**

**Single Door Models:**

Defrost timer is located in the lower right corner behind the louvered grill (inside galvanized electrical box).

Outer most dial. White tabs represent 15 minutes of defrost time.

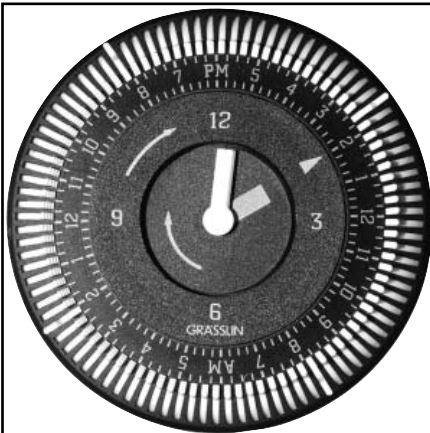

**Factory setting 2 am, 8 am, 2 pm, 8 pm. 15 minutes in length. True recommends maximum 15 minute defrost cycles & minimum 4 defrost periods per day.**

**Setting the timer:  
(UNPLUG UNIT FROM  
POWER SUPPLY!)**

**DO NOT SET THE TIME BY  
ROTATING THE "OUTER" DIAL.**

Turn the minute hand clockwise until the time of day on the outer dial is aligned with the triangle marker on the inner dial (two o'clock position).

**The following procedure may be followed to customize your needs.**

**STEP 1**

In order to program the time to begin the defrost cycle, flip the white tabs out to set the defrost time. To eliminate a defrost time flip the white tabs back toward the center of the Defrost Timer.

**ALL OTHER UNITS.  
Defrost System!**

*This defrost system is temperature terminated, however the time clock has been designed with a time termination back-up.*

**REQUIRED TOOLS:**

- Phillips Screwdriver
- 1/4" Nut Driver or Socket

**Locating The Defrost Timer:**

See page 2 for removing louver grill instructions.

**Two Door Models:**

Defrost timer is located in the middle of the cabinet, behind the louvered grill. Timer is mounted to the left of the centered ballast box (Inside of gray timer box).

**Three Door Models:**

Defrost timer is located on the left upright post behind the louvered grill (Inside of gray timer box).

**Setting the timer:  
(UNPLUG UNIT FROM  
POWER SUPPLY!)**

**DO NOT SET THE TIME BY  
ROTATING THE "OUTER" DIAL.**

Turn the minute hand clockwise until the time of day on the outer dial is aligned with the triangle marker on the inner dial (two o'clock position).

**The following procedure may be followed to customize your needs.**

**STEP 1**

In order to program the time to begin the defrost cycle, flip the white tabs out to set the defrost time. To eliminate a defrost time flip the white tabs back toward the center of the Defrost Timer.

**NOTE:**

**True recommends a minimum 30 minute (2 tabs) defrost cycle three times per day.**

**(Except T-19F/19FZ/23F).**

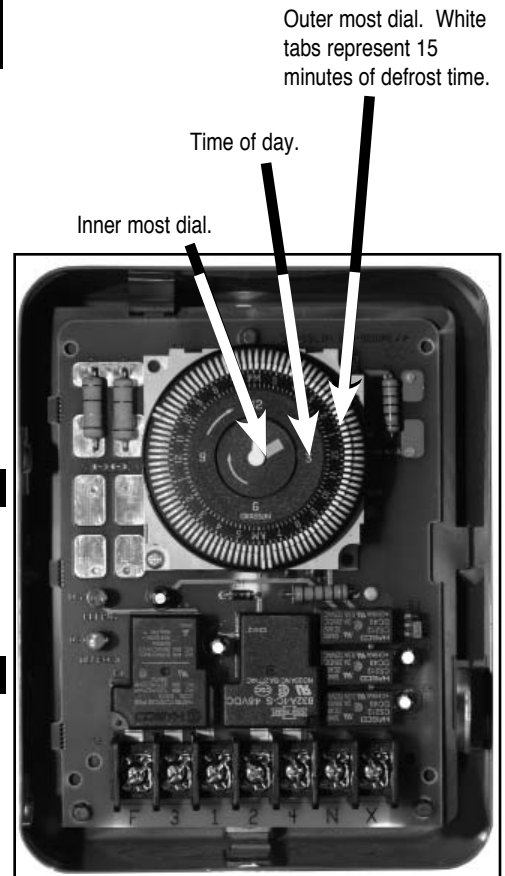

Outer most dial. White tabs represent 15 minutes of defrost time.

Time of day.

Inner most dial.

**Defrost Timer Box Image 1**

**All models except T-19F, T-19FZ, T-23F.**

The white tabs located on the outmost area of the time clock have been factory set for (6:00 a.m., 2:00 p.m., and 10:00 p.m.). Each tab represents 15 minutes of defrost time. Notice that at each defrost time two white tabs are set for 15 minutes each for a total of 30 minutes of defrost.

**WARNING:**

**High usage, high temperature, and high humidity may require additional defrost settings per day. Once clock is set & grill is correctly reinstalled cabinet can be plugged in.**



INSTALLATION / OPERATION INSTRUCTIONS

**IF THE COMPRESSOR WILL NOT RUN**

1. If there is no voltage at the compressor terminals, follow the wiring diagram and check back from compressor to the power supply to find where the circuit is interrupted.

2. If power is available at the compressor terminals, and the compressor does not run, check the voltage at the compressor terminals while attempting to start the compressor.

If voltage at the compressor terminals is below 90% of the nameplate voltage, it is possible the motor may not develop sufficient torque to start. Check to determine if wire sizes are adequate, electrical connections are loose, the circuit is overloaded, or if the power supply is inadequate.

3. On single phase compressors, a defective capacitor or relay may prevent the compressor starting. If the compressor attempts to start but is unable to do so, or if there is a humming sound, check the relay to see if the relay contacts are damaged or fused. The relay points should be closed during the initial starting cycle, but should open as the compressor comes up to speed.

Remove the wires from the starting relay and capacitors. Use a high voltage ohmmeter to check for continuity throughout the relay coil. Replace the relay if there is not continuity. Use an ohmmeter to check across the relay contacts. Potential relay contacts are normally closed when the relay is not energized, current relay contacts are normally open. If either gives an incorrect reading, replace the relay.

Any capacitor found to be bulging, leaking, or damaged should be replaced.

Make sure capacitors are discharged before checking. Check for continuity between each capacitor terminal and the case. Continuity indicates a short, and the capacitor should be replaced.

Substitute a "known to be good" start capacitor if available. If compressor then starts and runs properly, replace the original start capacitor.

If a capacitor tester is not available, an ohmmeter may be used to check run and start capacitors for shorts or open circuits. Use an ohmmeter set to its highest resistance scale, and connect prods to capacitor terminals.

a) With a good capacitor, the indicator should first move zero, and then gradually increase to infinity.

b) If there is no movement of the ohmmeter indicator, an open circuit is indicated.

c) If the ohmmeter indicator moves to zero, and remains there or on a low resistance reading, a short circuit is indicated. Defective capacitors should be replaced.

4. If the correct voltage is available at the compressor terminals, and no current is drawn, remove all wires from the terminals and check for continuity through the motor windings. On single phase motor compressors, check for continuity from terminals C to R, and C to S. On compressors with line break inherent protectors, an open overload protector can cause a lack of continuity. If the compressor is warm, wait one hour for the compressor to cool and recheck. If continuity cannot be established through all motor windings, the compressor should be replaced.

Check the motor for ground by means of a continuity check between the common terminal and the compressor shell. If there is a ground, replace the compressor.

5. If the compressor has an external protector, check for continuity through the protector or protectors. All external inherent protectors on compressors can be replaced in the field.

**IF THE MOTOR COMPRESSOR STARTS BUT TRIPS REPEATEDLY ON THE OVERLOAD PROTECTOR**

1. Check the compressor suction and discharge pressures while the compressor is operating. Be sure the pressures are within the limitations of the compressor. If pressures are excessive it may be necessary to clean the condenser, purge air from the system, replace crankcase pressure regulating valve.

An excessively low suction pressure may indicate a loss of charge.

On units with no service gauge parts where pressures can be checked, check condenser to be sure it is clean and fan is running. Excessive temperatures on suction and discharge line may also indicate abnormal operating conditions.

2. Check the line voltage at the motor terminals while the compressor is operating. The voltage should be within 10% of the nameplate voltage rating. If outside those limits, the voltage supply must be brought within the proper range, or a motor compressor with different electrical characteristics must be used.

3. Check the amperage drawn while the compressor is operating. Under normal operating conditions, the amperage drawn will seldom exceed 110% of the nameplate amperage. High amperage can be caused by low voltage, defective running capacitors, or a defective starting relay.

Continued on next page



## INSTALLATION / OPERATION INSTRUCTIONS

4. If all operating conditions are normal, the voltage supply at the compressor terminals balanced and within limits, the compressor crankcase temperature within normal limits, and the amperage drawn within the specified range, the motor protector may be defective, and should be replaced.

If the operating conditions are normal and the compressor is running excessively hot for no observable reason, or if the amperage drawn is above the normal range and sufficient to repeatedly trip the protector, the compressor has internal damage and should be replaced.

### **IF THE COMPRESSOR RUNS BUT WILL NOT REFRIGERATE**

1. Check the refrigerant charge. Check the evaporator surface to determine if it is evenly cold throughout, or if partially starved. A lack of charge may be indicated by light, fluffy frost at the evaporator inlet. Add refrigerant if necessary.

2. Check the compressor suction pressure. An abnormally low pressure may indicate a loss of refrigerant charge, a malfunctioning capillary tube, a lack of evaporator capacity possibly due to icing or low air flow, or a restriction in the system.

Often a restriction in a drier or strainer can be identified by frost or a decrease in temperature across the restriction due to the pressure drop in the line. This will be true only if liquid refrigerant is in the line at the restricted point, since any temperature change due to restriction would be caused by the flashing of liquid into vapor as the pressure changes.

Any abnormal restriction in the system must be corrected.

3. Check the compressor discharge pressure. An abnormally high discharge pressure can cause a loss of capacity, and can be caused by a dirty condenser, a malfunctioning condenser fan, or air in the system.

4. If the suction pressure is high, and the evaporator and condenser are functioning normally, check the compressor amperage draw. An amperage draw near or above the nameplate rating indicates normal compressor or unit may have damaged valves.

An amperage draw considerably below the nameplate rating may indicate a broken suction reed or broken connecting rod in the compressor.

### **DIAGNOSIS AND REPLACEMENT OF FREEZER CABINET COMPONENTS**

#### **1. Defrost Time Clock**

- A. Check timer motor to be sure it runs.
- B. Check contacts on the defrost timer.
- C. Check solenoid windings for continuity to ensure contact switching.
- D. Check to be sure defrost actuator pins are in proper position.
- E. Check all wires in the timer for tightness to terminals and broken wires.

#### **2. Defrost Control On The Evaporator Drain Pan**

A. If the defrost time is always 35 minutes (or whatever duration the elapsed time adjustment is set at) and the fan motors do not delay after a defrost cycle and it has been determined that the solenoid in the defrost clock is functioning, change the defrost control in the evaporator

compartment in the top of the freezer. This control is attached to the evaporator drain pan.

#### **3. Coil Defrost Heater**

A. Lower the evaporator cover. Disconnect the coil heater by removing the wire nuts at the point where the heater joins the electrical circuit of the freezer in the evaporator compartment. Check heater for continuity with an ohmmeter. If the heater is defective, cut the bale wires holding the heater to the coil and remove the heater. Replace with a new heater using bale wires provided.

#### **4. Drain Tube Heater**

A. Lower the evaporator cover. Disconnect the drain tube heater by removing the wire nuts at the point where the heater joins the electrical circuit of the freezer in the evaporator compartment. Check the drain tube heater with an ohmmeter.

B. If the drain tube heater is defective, disconnect the drain tube from the rigid plastic drain, bend the tabs that hold the evaporator drain pan to the evaporator cover and raise the drain pan so that the flexible heater is visible, pull heater out of the plastic drain tube and replace. Connect heater to the electrical circuit in the evaporator compartment.

#### **5. Cabinet Temperature Control**

A. Remove the two screws on the right side of the evaporator housing that holds the control mounting plate. Reach behind the evaporator housing on the control side of the cabinet and pull the control bulb out of the receptacle in the roof of the cabinet. Disconnect the wires from the control. Check control for continuity, replace if defective.

# Light Cover Installation for T-12FG

### REQUIRED TOOLS

- none

**- IMPORTANT -**  
 Before installing lamp cover  
 turn cabinet on and allow it to  
 reach temperature.

### STEP 1

Locate rubber gasket behind lamp holder  
 mounted to evaporator housing. (See  
 Image 1).

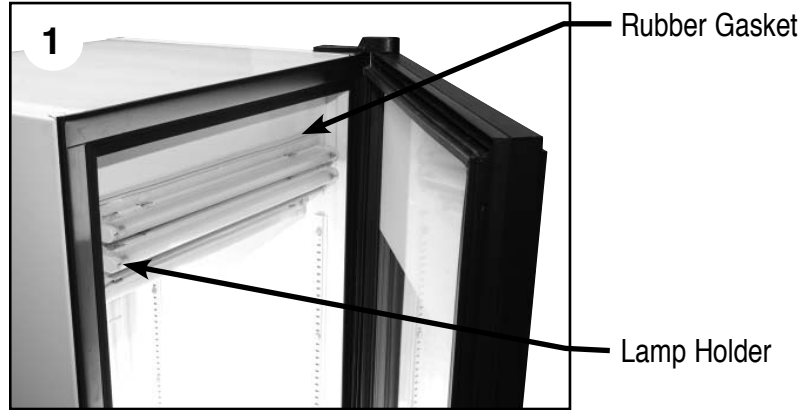

### STEP 2

Fit the bottom edge of the lamp cover  
 into the bottom groove of the rubber  
 gasket and rotate upwards while  
 working the edges into the rest of the  
 rectangular groove. (See Images 2-3).  
 (slide fingers underneath top edges of  
 rubber gasket and push rubber over the  
 top lip of the lamp shield)

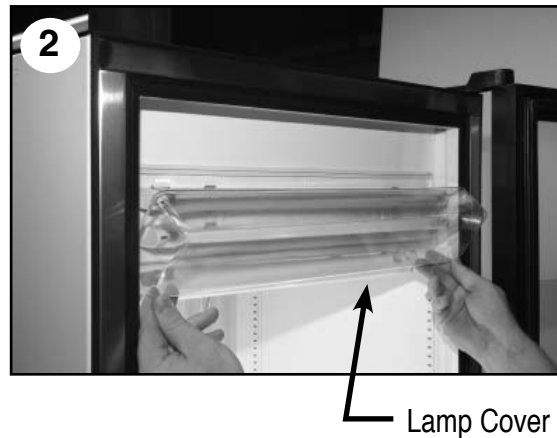

### STEP 3

Be sure lamp cover is seated properly in  
 rubber gasket.

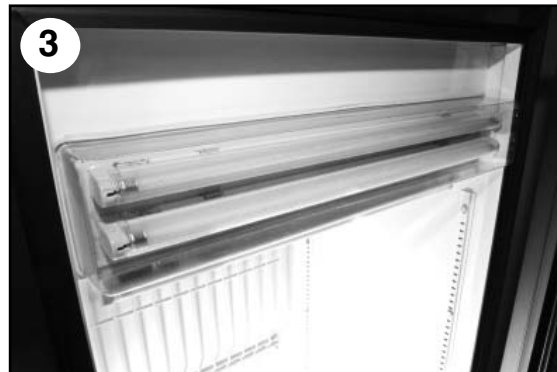

**- NOTE -**  
 If cabinet is turned off and  
 interior allowed to warm up  
 lamp cover may become loose  
 and require reinstallation.  
 Follow directions above.

MAINTENANCE, CARE & CLEANING

**MAINTENANCE, CARE & CLEANING**

**CLEANING THE CONDENSER COIL**

When using electrical appliances, basic safety precautions should be followed, including the following:

**REQUIRED TOOLS:**

- Phillips Screwdriver
- Stiff Bristle Brush
- Adjustable Wrench
- Air Tank or CO<sub>2</sub> Tank
- Vacuum Cleaner

**Step 1**

Disconnect power to unit.

**Step 2**

SLIDE DOOR MODELS: (See Image 1)

Take off lower grill assembly by removing two (2) screws in lower corners. (older models may have snap lock tabs instead of screws).

Loosen screws holding the top pivot pins. Swing grill up and remove frame hooks from pivot pins at top of louver.

SWING DOOR MODELS: (See Image 2)

Take off lower grill assembly by opening the door and removing screws from the top of the louver grill. Some models have a door light switch. Please use caution when removing the grill on these models. Do not pinch wires. For reinstall, reattach the grill to the magnets on front of the cabinet and reinstall the screws on top of the grill.

**Step 3**

Remove bolts anchoring compressor assembly to frame rails and carefully slide out. (tube connections are flexible)

**Step 4**

Clean off accumulated dirt from the condenser coil and the fan with a stiff bristle brush.

**Step 5**

Lift cardboard cover above fan at plastic plugs and carefully clean condenser coil and fan blades.

**Step 6**

**INDOOR LOCATION:**

After brushing condenser coil vacuum dirt from coil, and interior floor.

**OUTDOOR LOCATION:**

(GDM-33, GDM-47, and GDM-49 only) After brushing condenser coil blow CO<sub>2</sub> through condenser from fin side to fan. (See Image 4.)

**Step 7**

Replace cardboard cover. Carefully slide compressor assembly back into position and replace bolts.

**Step 8**

Reinstall louver assembly onto unit with appropriate fastener and clips. Tighten all screws.

**Step 9**

Connect unit to power and check to see if compressor is running.



Image 1. Slide Door Models

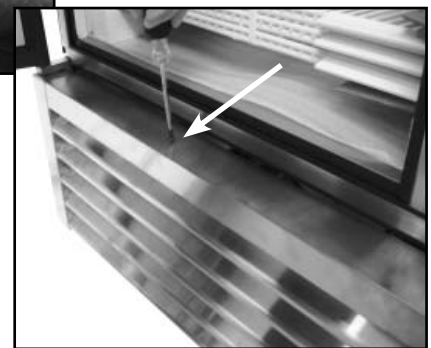

Image 2. Swing Door Models

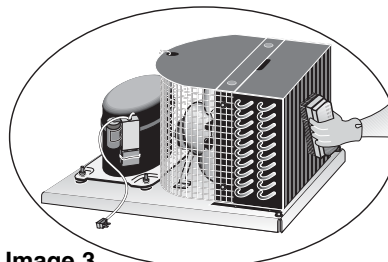

Image 3.

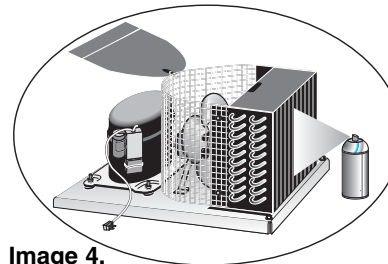
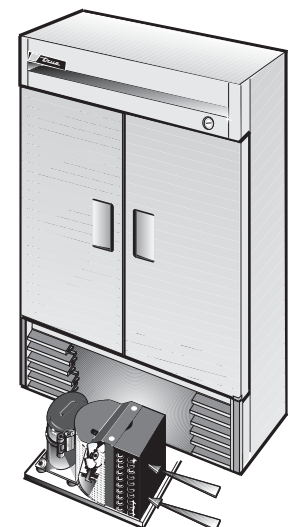

Image 4.



MAINTENANCE, CARE & CLEANING

**IMPORTANT WARRANTY INFORMATION**

Condensers accumulate dirt and require cleaning every 30 days. Dirty condensers result in compressor failure, product loss, and lost sales... which are not covered by warranty.

If you keep the Condenser clean you will minimize your service expense and lower your electrical costs. The Condenser requires scheduled cleaning every thirty days or as needed.

Air is pulled through the Condenser continuously, along with dust, lint, grease, etc.

A dirty Condenser can result in **NON-WARRANTEED** part & Compressor Failures, Product Loss, and Lost Sales.

Proper cleaning involves removing dust from the Condenser. By using a soft brush, or vacuuming the Condenser with a shop vac, or using CO2, nitrogen, or pressurized air.

If you cannot remove the dirt adequately, please call your refrigeration service company.

On most of the units the condenser is accessible in the rear of the unit. You must remove the cabinet grill to expose the Condenser.

The Condenser looks like a group of vertical fins. You need to be able to see through the condenser for the unit to function at maximum capacity. Do not place filter material in front of condensing coil. This material blocks air-flow to the coil similar to having a dirty coil.

**THE CLEANING OF THE CONDENSER IS NOT COVERED BY THE WARRANTY!**

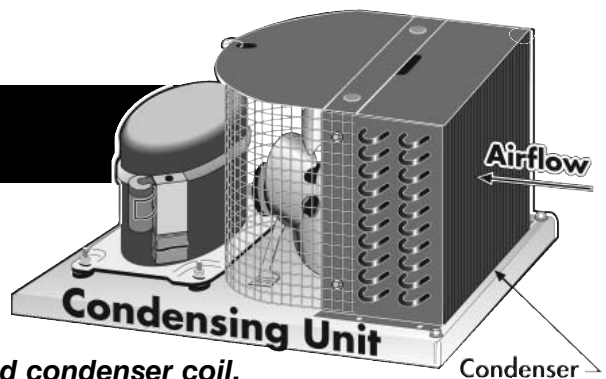

**HOW TO CLEAN THE CONDENSER:**

1. Disconnect the electrical power to the unit.
2. Remove the louvered grill.
3. Vacuum or brush the dirt, lint, or debris from the finned condenser coil.
4. If you have a significant dirt build up you can blow out the condenser with compressed air. (CAUTION MUST BE USED to avoid eye injury. Eye protection is recommended.)
5. When finished be sure to replace the louvered grill. The grill protects the condenser.
6. Reconnect the electrical power to the unit.

If you have any questions, please call True Manufacturing at 636-240-2400 or 800-325-6152 and ask for the Service Department. Service Department Availability Monday-Friday 7:30 a.m. to 5:30p.m.

and Saturday 8:00 a.m. to 12:00 a.m. CST.

# TEMPERATURE CONTROL ADJUSTMENT FOR HIGH ALTITUDE ONLY!

**TERMS:**

Cut-out - Temperature sensed by the controller that shuts the compressor off.

Cut-in - Temperature sensed by the controller that turns the compressor on.

**REQUIRED TOOLS**

- Phillips Head Screwdriver
- 5/64" or 2 mm Allen Wrench
- T-7 Torx Wrench

\_\_\_\_\_ **STEP 1** \_\_\_\_\_

Unplug the cooler.

\_\_\_\_\_ **STEP 2** \_\_\_\_\_

Remove the screws that secure the temperature control to the inset box lower left side of the cabinet (when facing the front of the cabinet).

\_\_\_\_\_ **STEP 3** \_\_\_\_\_

Pull out gently from cabinet.

**NOTE:**

Mechanical temperature controllers are affected when functioning at high altitude. The cut-in and cut-out temperatures will be colder than when the controller functions closer to sea level.

\_\_\_\_\_ **STEP 4** \_\_\_\_\_

For high elevation installations, it may be necessary to "warm-up" the set points. To make the adjustment, insert the appropriate tool in each adjustment screw and turn 1/4 of a revolution clockwise (to the right). This procedure will adjust both the cut-in and cut-out about 2°F warmer.

\_\_\_\_\_ **STEP 5** \_\_\_\_\_

Make sure to reconnect the pink wire to the proper spade terminal when reinstalling.

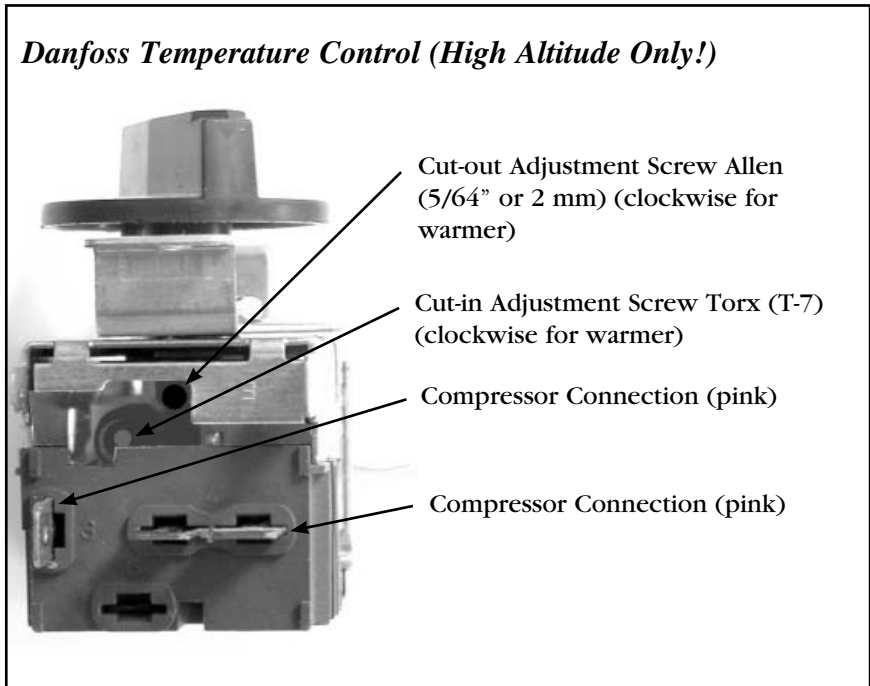

MAINTENANCE, CARE & CLEANING

## **Stainless Steel Equipment Care and Cleaning**

**CAUTION: Do not use any steel wool, abrasive or chlorine based products to clean stainless steel surfaces.**

### ■ Stainless Steel Opponents

There are three basic things which can break down your stainless steel's passivity layer and allow corrosion to rear its ugly head.

- 1) Scratches from wire brushes, scrapers, and steel pads are just a few examples of items that can be abrasive to stainless steel's surface.
- 2) Deposits left on your stainless steel can leave spots. You may have hard or soft water depending on what part of the country you live in. Hard water can leave spots. Hard water that is heated can leave deposits if left to sit too long. These deposits can cause the passive layer to break down and rust your stainless steel. All deposits left from food prep or service should be removed as soon as possible.
- 3) Chlorides are present in table salt, food, and water. Household and industrial cleaners are the worst type of chlorides to use.

### ■ 8 steps that can help prevent rust on stainless steel:

#### 1. Using the correct cleaning tools

Use non-abrasive tools when cleaning your stainless steel products. The stainless steel's passive layer will not be harmed by soft cloths and plastic scouring pads. Step 2 tells you how to find the polishing marks.

#### 2. Cleaning along the polish lines

Polishing lines or "grain" are visible on some stainless steels. Always scrub parallel to visible lines on some stainless steels. Use a plastic scouring pad or soft cloth when you cannot see the grain.

#### 3. Use alkaline, alkaline chlorinated or non-chloride containing cleaners

While many traditional cleaners are loaded with chlorides, the industry is providing an ever increasing choice of non-chloride cleaners. If you are not sure of your cleaner's chloride content contact your cleaner supplier. If they tell you that your present cleaner contains chlorides, ask if they have an alternative. Avoid cleaners containing quaternary salts as they can attack stainless steel, causing pitting and rusting.

#### 4. Water Treatment

To reduce deposits, soften the hard water when possible. Installation of certain filters can remove corrosive and distasteful elements. Salts in a properly maintained water softener can be to your advantage. Contact a treatment specialist if you are not sure of the proper water treatment.

#### 5. Maintaining the cleanliness of your food equipment

Use cleaners at recommended strength (alkaline, alkaline chlorinated or non-chloride). Avoid build-up of hard stains by cleaning frequently. When boiling water with your stainless steel equipment, the single most likely cause of damage is chlorides in the water. Heating any cleaners containing chlorides will have the same damaging effects.

#### 6. Rinse

When using chlorinated cleaners you must rinse and wipe dry immediately. It is better to wipe standing cleaning agents and water as soon as possible. Allow the stainless steel equipment to air dry. Oxygen helps maintain the passivity film on stainless steel.

#### 7. Hydrochloric acid (muriatic acid) should never be used on stainless steel

#### 8. Regularly restore/passivate stainless steel

# Stainless Steel Equipment Care and Cleaning

Recommended cleaners for certain situations / environments of stainless steel

- A) Soap, ammonia and detergent medallion applied with a cloth or sponge can be used for routine cleaning.
- B) Arcal 20, Lac-O-Nu Ecoshine applied provides barrier film for fingerprints and smears.
- C) Cameo, Talc, Zud First Impression is applied by rubbing in the direction of the polished lines for stubborn stains and discoloring.
- D) Easy-off and De-Grease It oven aid are excellent for removals on all finishes for grease-fatty acids, blood and burnt-on foods.
- E) Any good commercial detergent can be applied with a sponge or cloth to remove grease and oil.
- F) Benefit, Super Sheen, Sheila Shine are good for restoration / passivation.

**NOTE:**  
*The use of stainless steel cleaners or other such solvents is not recommended on plastic parts. Warm soap and water will suffice.*

## LIGHT BULB REPLACEMENT

### IDL (Integrated Door Lighting)

**WARNING:**

Disconnect power to cabinet before replacing light bulbs.

### INTERIOR LIGHTS:

- Simply unscrew the light bulb(See Image 1 & 2).

### IDL (INTEGRATED DOOR LIGHTING):

- Squeeze the plastic lampshield together and pull away from the door (See Image 3).
- Push the bulb down while pulling the spring activated lampholder up. This will give you enough clearance to take the bulb out (See Image 4).



Interior Light



Interior Light



IDL (Integrated Door Lighting)



IDL (Integrated Door Lighting)





## WARRANTY INFORMATION (U.S.A & CANADA ONLY!)

### ONE YEAR PARTS & LABOR WARRANTY

TRUE warrants to the original purchaser of every new TRUE refrigerated unit, the cabinet and all parts thereof, to be free from defects in material or workmanship, under normal and proper use and maintenance service as specified by TRUE and upon proper installation and start-up in accordance with the instruction packet supplied with each TRUE unit. TRUE's obligation under this warranty is limited to a period of one (1) year from the date of original installation or 15 months after shipment date from TRUE, whichever occurs first.

Any part covered under this warranty that are determined by TRUE to have been defective within one (1) year of original installation or fifteen (15) months after shipment date from manufacturer, whichever occurs first, is limited to the repair or replacement, including labor charges, of defective parts or assemblies. The labor warranty shall include standard straight time labor charges only and reasonable travel time, as determined by TRUE.

### ADDITIONAL FOUR YEAR COMPRESSOR WARRANTY

In addition to the one (1) year warranty stated above, TRUE warrants its hermetically and semi-hermetically sealed compressor to be free from defects in both material and workmanship under normal and proper use and maintenance service for a period of four (4) additional years from the date of original installation but not to exceed five (5) years and three (3) months after shipment from the manufacturer.

Compressors determined by TRUE to have been defective within this extended time period will, at TRUE's option, be either repaired or replaced with a compressor or compressor parts of similar design and capacity.

The four (4) year extended compressor warranty applies only to hermetically and semi-hermetically sealed parts of the compressor and does not apply to any other parts or components, including, but not limited to, cabinet, paint finish, temperature control, refrigerant, metering device, driers, motor starting equipment, fan assembly or any other electrical component, etcetera.

### 404A/134A COMPRESSOR WARRANTY

The four year compressor warranty detailed above will be voided if the following procedure is not carefully adhered to:

1. This system contains R404A or R134A refrigerant and polyol ester lubricant. The polyol ester lubricant has rapid moisture absorbing qualities. If long exposure to the ambient conditions occur, the lubricant must be removed and replaced with new. For oil amounts and specifications please call True technical service department (800-325-6152). Failure to comply with recommended lubricant specification will void the compressor warranty.
2. Drier replacement is very important and must be changed when a system is opened for servicing. A drier using XH-7 desiccant or an exact replacement solid core drier must be used. The new drier must also be the same capacity as the drier being replaced.
3. Micron level vacuums must be achieved to insure low moisture levels in the system. 500 microns or lower must be obtained.

### WARRANTY CLAIMS

All claims for labor or parts must be made directly through TRUE. All claims should include: model number of the unit, the serial number of the cabinet, proof of purchase, date of installation, and all pertinent information supporting the existence of the alleged defect.

In case of warranty compressor, the compressor model tag must be returned to TRUE along with above listed information. Any action or breach of these warranty provisions must be commenced within one (1) year after that cause of action has occurred.

### WHAT IS NOT COVERED BY THIS WARRANTY

TRUE's sole obligation under this warranty is limited to either repair or replacement of parts, subject to the additional limitations below. This warranty neither assumes nor authorizes any person to assume obligations other than those expressly covered by this warranty.

**NO CONSEQUENTIAL DAMAGES.** TRUE IS NOT RESPONSIBLE FOR ECONOMIC LOSS; PROFIT LOSS; OR SPECIAL, INDIRECT, OR CONSEQUENTIAL DAMAGES, INCLUDING WITHOUT LIMITATION, LOSSES OR DAMAGES ARISING FROM FOOD OR PRODUCT SPOILAGE CLAIMS WHETHER OR NOT ON ACCOUNT OF REFRIGERATION FAILURE.

**WARRANTY IS NOT TRANSFERABLE.** This warranty is not assignable and applies only in favor of the original purchaser/user to whom delivered. ANY SUCH ASSIGNMENT OR TRANSFER SHALL VOID THE WARRANTIES HEREIN MADE AND SHALL VOID ALL WARRANTIES, EXPRESS OR IMPLIED, INCLUDING ANY WARRANTY OF MERCHANTABILITY OR FITNESS FOR A PARTICULAR PURPOSE.

**IMPROPER USAGE.** TRUE ASSUMES NO LIABILITY FOR PARTS OR LABOR COVERAGE FOR COMPONENT FAILURE OR OTHER DAMAGES RESULTING FROM IMPROPER USAGE OR INSTALLATION OR FAILURE TO CLEAN AND/OR MAINTAIN PRODUCT AS SET FORTH IN THE WARRANTY PACKET PROVIDED WITH THE UNIT.

**RESIDENTIAL APPLICATIONS:** True assumes no liability for parts or labor coverage for component failure or other damages resulting from installation in non-commercial or residential applications.

**ALTERATION, NEGLIGENCE, ABUSE, MISUSE, ACCIDENT, DAMAGE DURING TRANSIT OR INSTALLATION, FIRE, FLOOD, ACTS OF GOD.** TRUE is not responsible for the repair or replacement of any parts that TRUE determines have been subjected after the date of manufacture to alteration, neglect, abuse, misuse, accident, damage during transit or installation, fire, flood, or act of God.

**IMPROPER ELECTRICAL CONNECTIONS.** TRUE IS NOT RESPONSIBLE FOR THE REPAIR OR REPLACEMENT OF FAILED OR DAMAGED COMPONENTS RESULTING FROM ELECTRICAL POWER FAILURE, THE USE OF EXTENSION CORDS, LOW VOLTAGE, OR VOLTAGE DROPS TO THE UNIT.

**NO IMPLIED WARRANTY OF MERCHANTABILITY OR FITNESS FOR A PARTICULAR PURPOSE:** THERE ARE NO OTHER WARRANTIES, EXPRESSED, IMPLIED OR STATUTORY, EXCEPT THE ONE (1) YEAR PARTS & LABOR WARRANTY AND THE ADDITIONAL FOUR (4) YEAR COMPRESSOR WARRANTY AS DESCRIBED ABOVE. THESE WARRANTIES ARE EXCLUSIVE AND IN LIEU OF ALL OTHER WARRANTIES, INCLUDING IMPLIED WARRANTY AND MERCHANTABILITY OR FITNESS FOR A PARTICULAR PURPOSE. THERE ARE NO WARRANTIES WHICH EXTEND BEYOND THE DESCRIPTION ON THE FACE HEREOF.

**OUTSIDE U.S./Canada:** This warranty does not apply to, and TRUE is not responsible for, any warranty claims made on products sold or used outside the United States or Canada.